



ESO safety training for work on vehicles with high-voltage systems

Society of Automotive Engineers of Japan, Inc.

Introduction

- As part of the safety training for the EV class of the Formula SAE Japan Competition organized by the Society of Automotive Engineers of Japan, ESO training will be provided. **ESOs of EV Class participating teams must review the training materials provided by the organizer, pass the web-based test with the required score.**
The purpose of this examination is to enhance safety knowledge and does not certify qualification by the Society.
- This slide provides important knowledge and procedures for working safely. It is recommended that not only ESOs (Electrical System Officers), ESAs (Electric System Advisors) and FAs (Faculty Advisors), but also **all team members involved in the design and work, understand how to work safely from this document.**
- Work on vehicles containing storage low voltage batteries with ground voltages exceeding 50 volts is designated as "dangerous or hazardous work", and operators are required to provide the specified special training when workers are engaged in dangerous or hazardous work (Industrial Safety and Health Act under the Japanese Law).
This document is an excerpt of the above special training and in addition applies it to the unique structure of vehicles used in the Formula SAE Japan Competition organized by the Society of Automotive Engineers of Japan, Inc.

Explanation of terminology

- Voltage of 750 V DC or lower is classified as "low voltage" under Japanese Law. However, note that the term "High Voltage" is used in accordance with the terminology used in Formula SAE® Rules 2024 to clarify the difference from low-voltage circuits that are driven by 12V/24V.

ESO's role in safe operations?

The ESO is the person **responsible for the safety management of with directly directing the high-voltage work**

2024 FSAEJ Participation Rules, Article 11 (4)

An ESO must accompany the car whenever it is operated or moved around the event site.

SAE Rule EV.11.1.1

- Is the only person on the team that may declare the vehicle electrically safe to allow work on any system
- Must accompany the vehicle when operated or moved at the competition site

The ESO's need to know the role and responsibilities from this document.

Teams need to be able to electrical work safely.
All team members should aim to work safely.

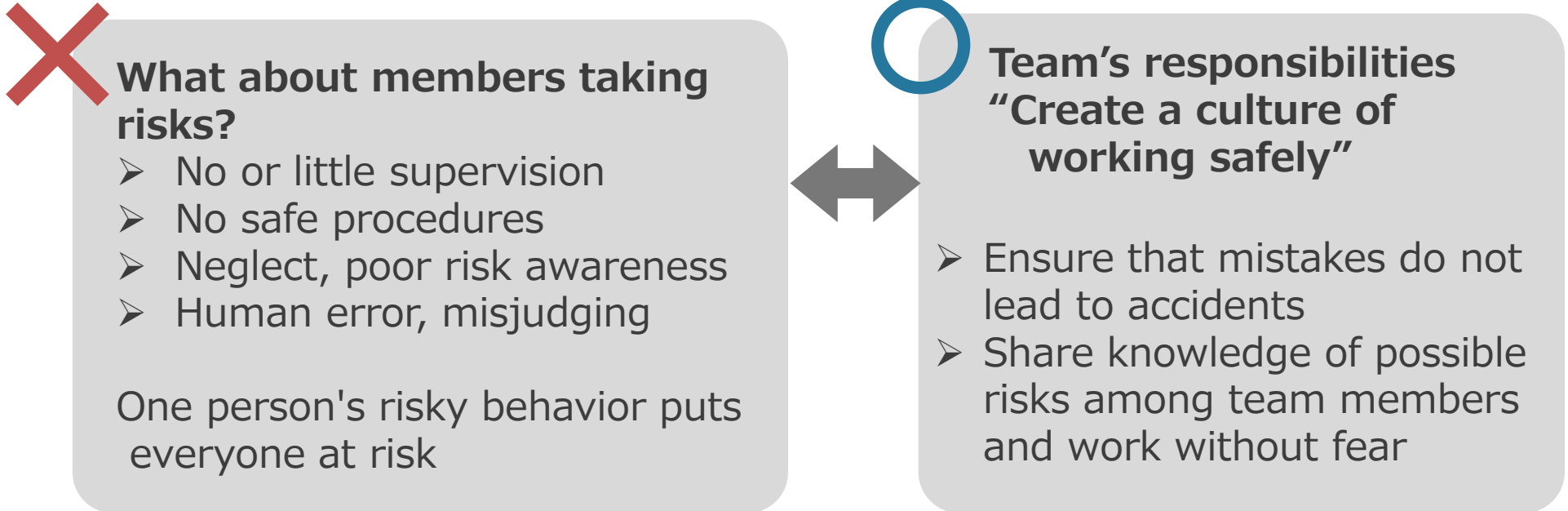

Members have to aspire to safety to carry out your responsibilities.
ESOs direct your members based on knowledge and information.

Team's responsibility "Organizing safe work under HV risks"

HV: high-voltage

Responsibilities of ESO

- Direct the work directly
- Prevent deviations from predetermined safe procedures
- Gather information and make improvements to prevent accidents

This text provides

Knowledge required for safe work

- Components, vehicle systems
- High-voltage risks
- Rules, protective equipment

ESO will be given . . .

Progressive information from work

- Worker's personality & health
- Conversation between members
- Status of tasks

ESO need to understand what is going on

Responsibilities of all members

- Follow the rules to prevent accidents
- Work together to prevent disasters
 - Report accidents, near misses, and hazards promptly
 - Learn what they need to know about the work

Always follow the rules set by the team for the safety of all members

Structure of this text

The text addresses the following chapters on the three required topics on HV work

- Competence of members
competence: Ability to work
 - Hazards of working with high voltage (chapter 1)
 - Knowledge of EV systems and components (chapter 2)
 - Knowledge of protective equipment (chapter 3)
 - Rules for working with high voltage (chapter 4)
 - Examples of past troubles (Chapter 5)
 - First aid in case of incident (Chapter 6)

- Procedure of the work
 - Knowledge of systems and electrical wiring specific to the team's vehicle
 - Actual procedures to avoid possible risks
 - Safety in working with EVs (Chapter7)

- Personal protective equipment and other equipment to be used (chapter-3)

Contents

- 1. Low Voltage Electricity Hazard (750V DC or less, 600V AC or less)**
2. Basic knowledge of high-voltage components in JSAE Formula EVs
3. Basic knowledge of personal protective equipment and tools
4. Electric work on high-voltage systems
5. Trouble in the past
6. First aid in the case of incident and fire extinguishing
7. Safety in working with EVs

Chapter 1

Low Voltage Electricity Hazard

(Low-voltage in Japanese Law is “ $\leq 750\text{V DC}$, $\leq 600\text{V AC}$ ”)

Classification of electricity

Electricity is classified into "low voltage", "high voltage" and "special high voltage" according to DC/AC and voltage magnitude.

(Industrial Safety and Health Regulations Article 36, Japanese Law)

In Formula SAE EVs, the battery voltage is DC 60V~600V, so it is classified as "low voltage".

In chapter 2 following chapters, circuits below 750Vdc are defined as "high-voltage" circuit to distinguish them from "low-voltage" circuit (12V/24Vdc).

("Formula SAE® Rules 2024" terminology compliant)

	DC	AC
Low Voltage	750V or less	600V or less
High Voltage	over750V~7000V or less	over600V~7000V or less
Extra High Voltage	Over 7000V	

Industrial Safety and Health Regulations Article 36

Electric Shock

More than 10 deaths due to electric shock occur every year.

The highest number of accidents occurs at low voltage range such as 100 V and 200 V.
You must work very carefully in Formula SAE EV.

Number of deaths and ratio from electric shock per voltage range (2006~2010)
(Unit : person)

Year	Voltage range		Lightning Strike 	Total
	Low Voltage ≤750Vdc, ≤600Vac	High Voltage & Extra High Voltage		
2006	15	3	1	19
2007	9	5		14
2008	10	10	1	21
2009	11	3		14
2010	11	2		13
Total	56	23	2	81
Ratio	69%	28%	3%	100%

(Data from Ministry of Health, Labour and Welfare)

Electric shock and effects on the human body

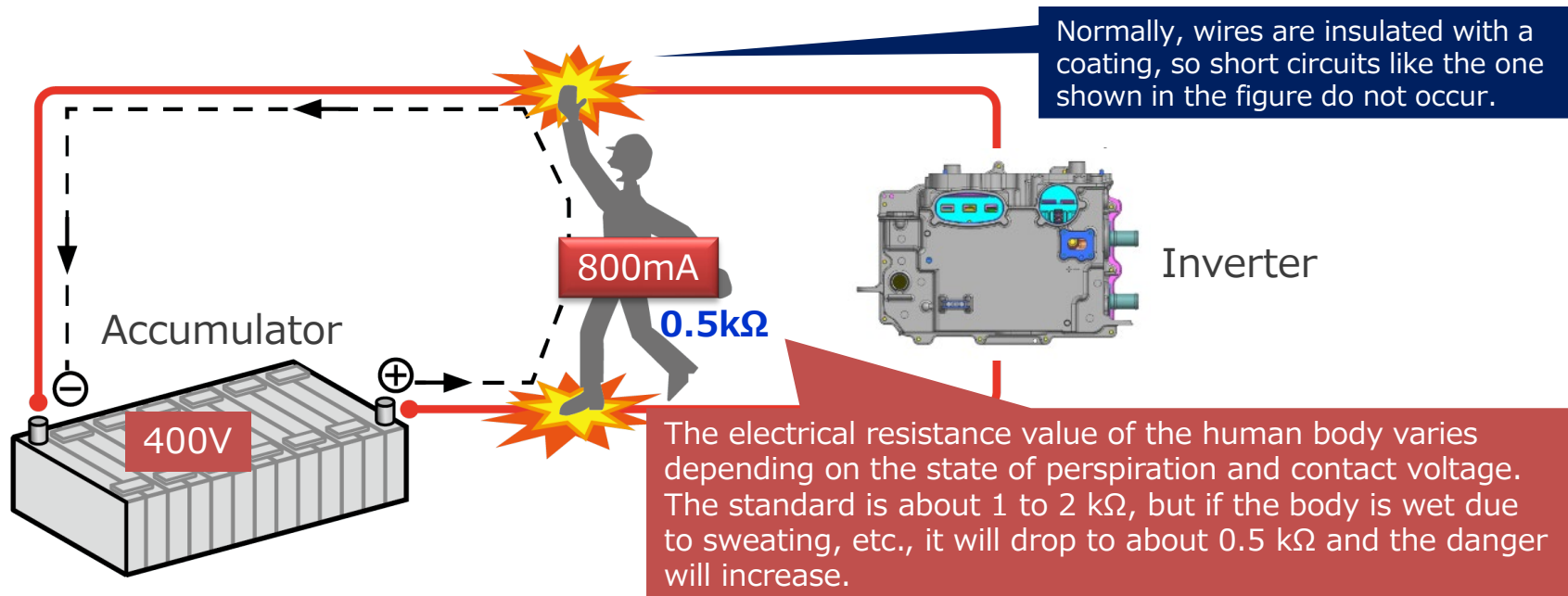

Electric current in human body (mA) (DC, 1 second continuous)	Effects on the human body
2 or less	Feel nothing
2~40	Feel shock or heat
40~150	Muscle spasms or difficulty breathing
150 or more	Ventricular fibrillation(※). Very dangerous. The risk increases as the current increases.

(※) Ventricular fibrillation: An abnormal heart beating that is life threatening.

Short-circuit

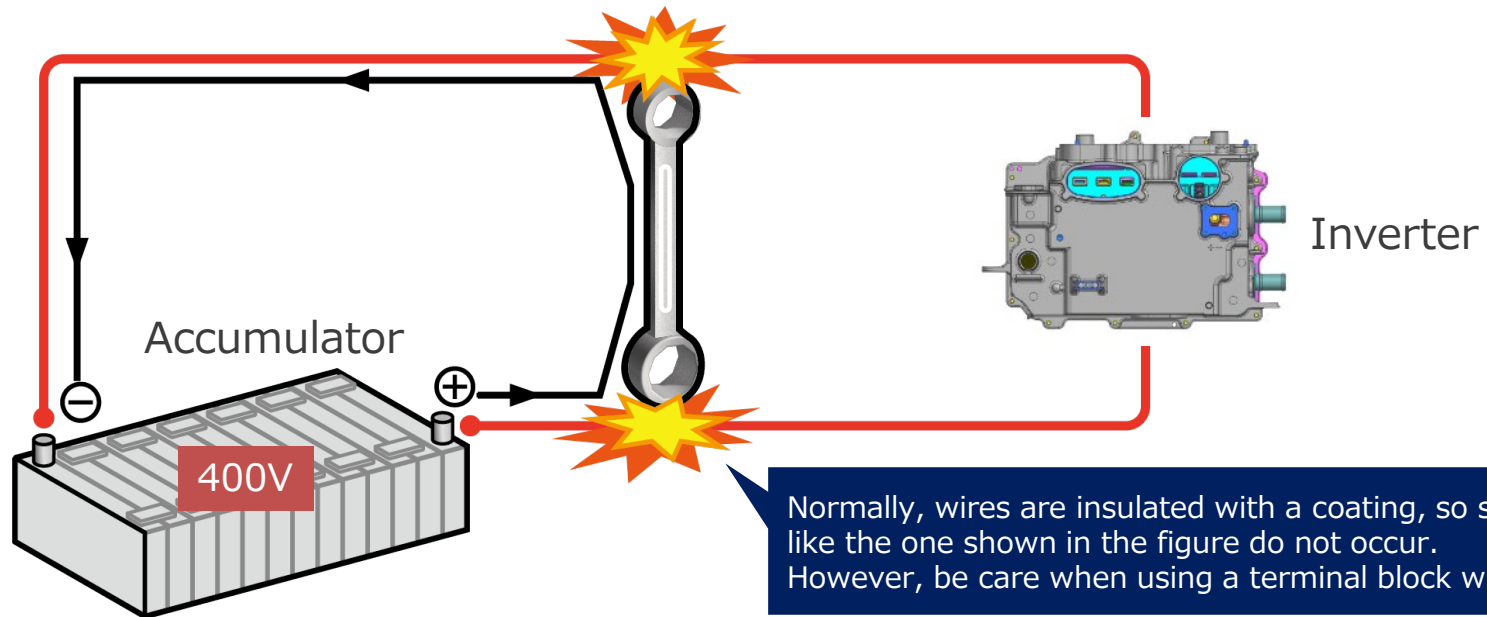

$$I \text{ (Current)} = \frac{E \text{ (Voltage)}}{R \text{ (Resistance)}} = \frac{400V}{\text{nearly } 0 \Omega} = \infty \text{ (Large current)}$$

Since a short circuit causes a large current to flow, the wire harness is burned, resulting in burns or fire.

Short circuits are often caused by operating errors such as dropping non-insulated tools on non-insulated high-voltage terminals.

Therefore, it is important to cover high-voltage terminals and to insulate metal tools.

Short-circuit

A battery pack or inverter capacitors
short circuit current is several 1,000 A

If the battery shorts out, the
entire round terminal is lost.

Superheating of plug/connector/wire (excessive current)

Cord reel



Applied excessive force may
result in ignition or short circuit

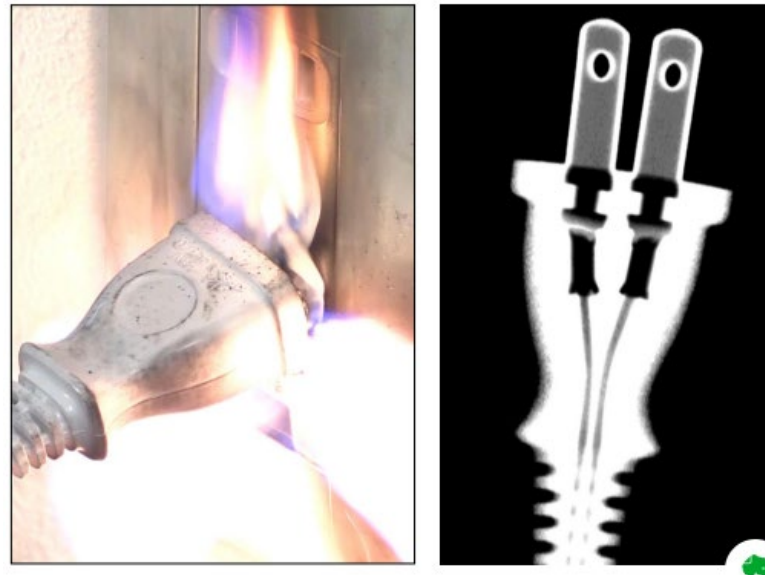

Electrical insulation failure

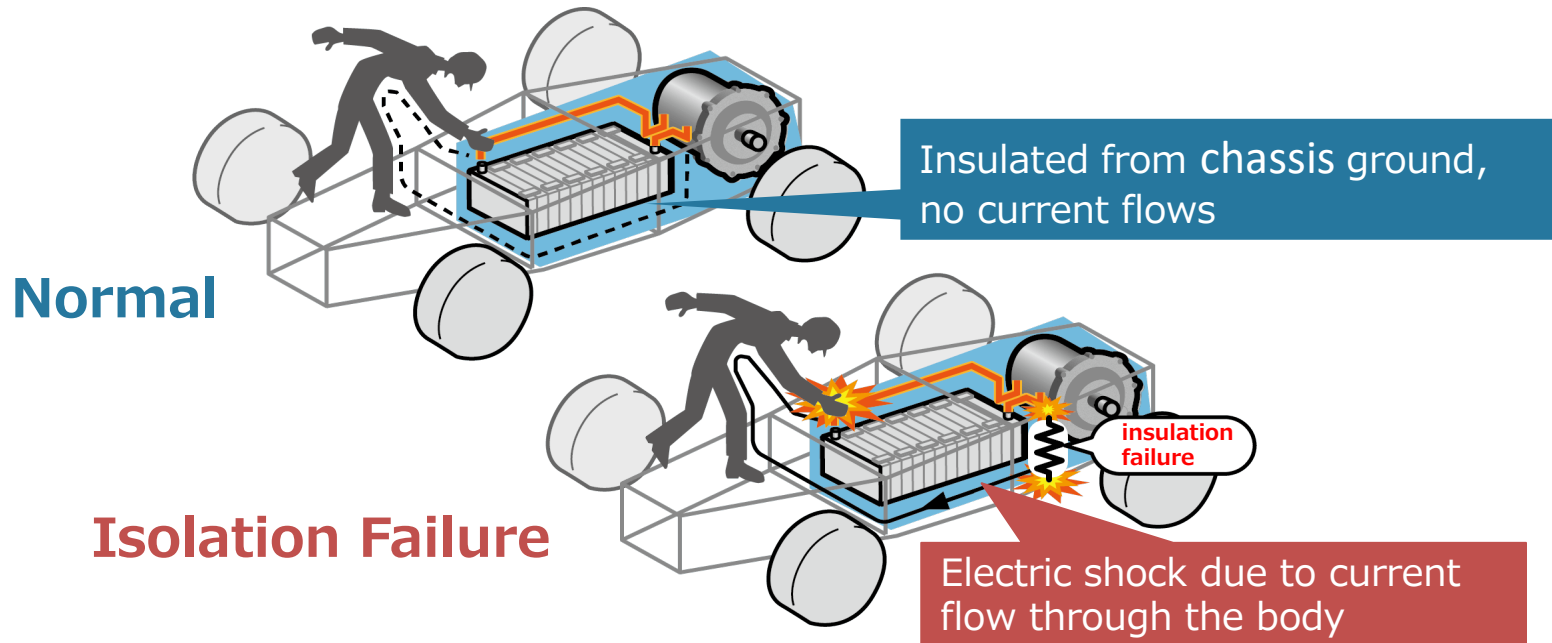

When normal , the electrical circuit of the tractive system (=TS) is isolated from the vehicle chassis (chassis ground).

Even if a person touches both the HV live-part and the body ground, there is no current flows.

If HV isolation failure occurs, current flows and it can cause an electric shock.

Causes of insulation failure include damage or aging of the wire insulation coating, etc.

The wires must be secured to the chassis to protect them from damage.



Insulation Resistance

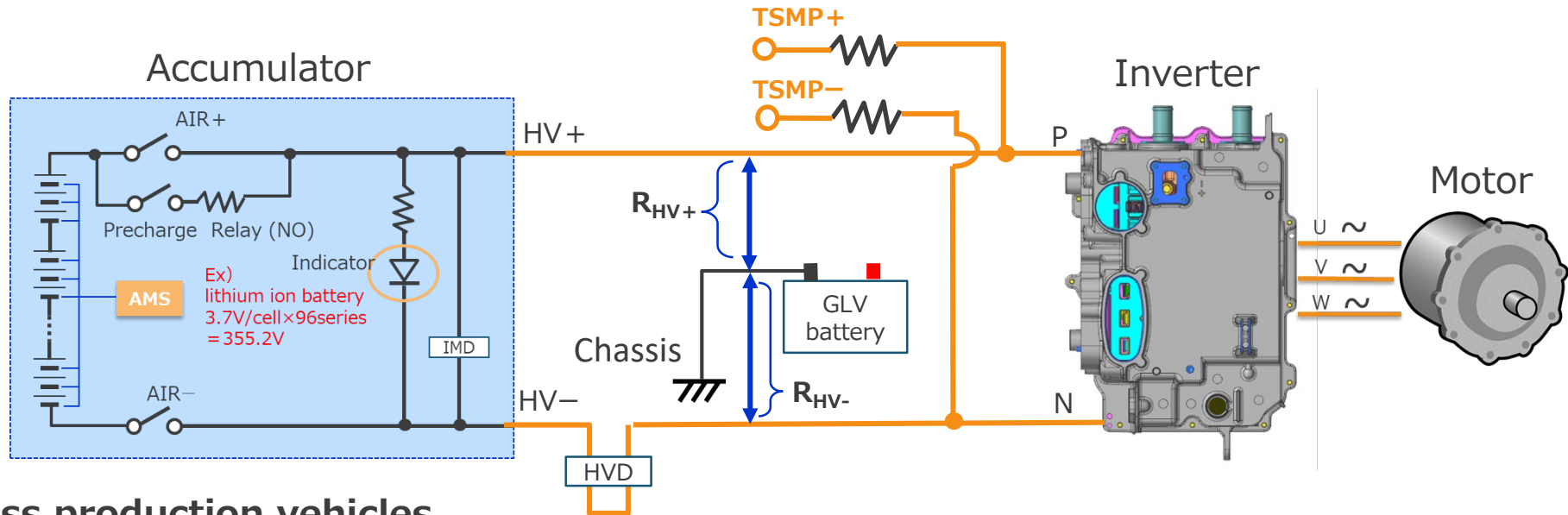

Mass production vehicles

If the insulation resistance between the HV and the low-voltage (LV) ground is $\leq 100 \Omega/V$ (R_{HV+} R_{HV-} in figure above), the vehicle must alert the driver.
(The Ministry of Land, Infrastructure, Transport and Tourism in Japanese Law)

Formula SAE EVs

In the Formula SAE® Rules 2024 (IN.4.5.3), **insulation resistance must be $\geq 500 \Omega/V$** . If the **"Insulation Monitoring Device (IMD)"** detects insulation failure ($< 500 \Omega/V$), the HV should be disconnected (AIRs should be switched off by a shutdown circuit).

Note for vehicle maintenance

Before and after HV maintenance of the vehicle, insulation resistance must be measured with an **"isolation resistance tester"** instead of a general multimeter. (see chapter.3)
Wear HV insulating gloves when using the isolation resistance tester as high voltage is applied.

Contents

1. Low Voltage Electricity Hazard (750V DC or less, 600V AC or less)
- 2. Basic knowledge of high-voltage components in JSAE Formula EVs**
3. Basic knowledge of personal protective equipment and tools
4. Electric work on high-voltage systems
5. Trouble in the past
6. First aid in the case of incident and fire extinguishing
7. Safety in working with EVs

Chapter 2

Basic knowledge of high-voltage components in Formula SAE EVs

Example of Vehicle System

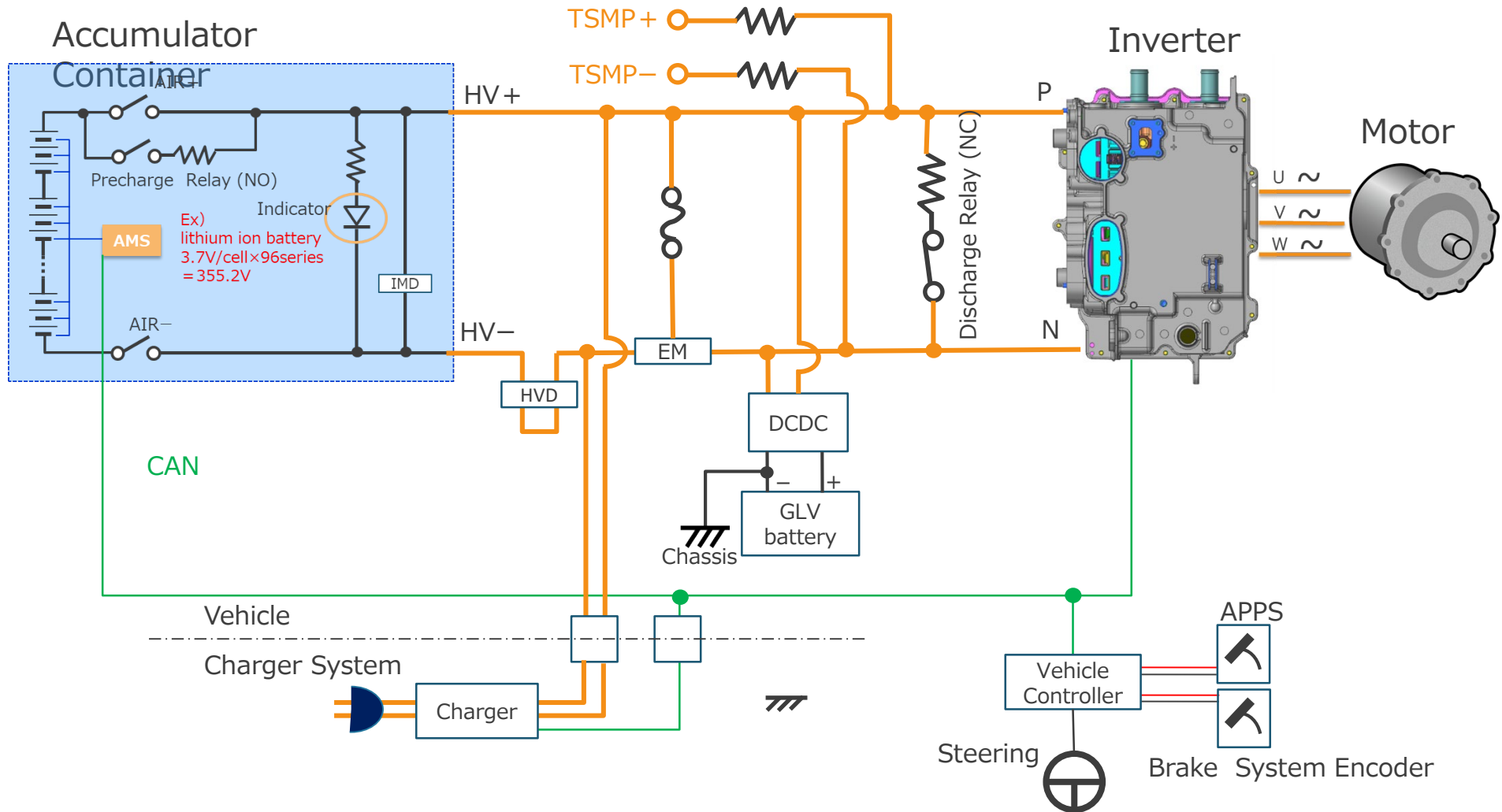

Major Components above are defined by Formula SAE rules

- Accumulator container
- Motor
- Inverter
- IMD
- AMS
- HVD
- DC-DC converter
- Power cable
- Energy Meter
- APPS
- BSE
- GLV Battery
- Vehicle Controller
- Charger

Traction system (=TS) is electrically connected components to the motor(s) and/or accumulator(s)

If TS is high-voltage ($\geq 60V$ defined in T.9.1.2), TS is high-voltage system.

Example of control system diagram

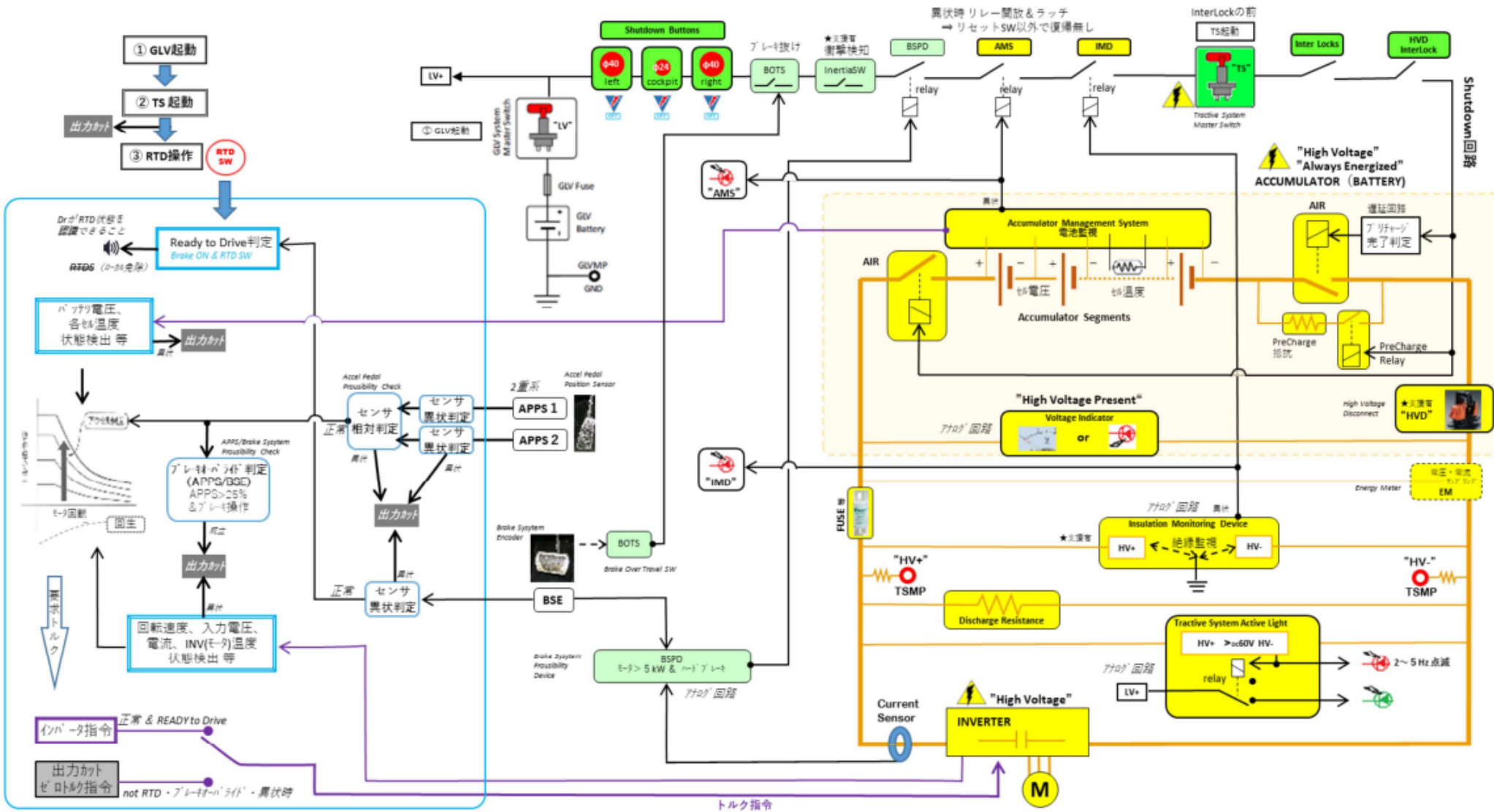

Isolation between TS-circuits and GLV-circuits

Components on the gray-line and above gray-line are TS components.

Galvanic isolations are needed on the gray-line boundary in the below schematic, if TS is >60V.
If TS is not isolated, there is risk of electrical shock.

Galvanic isolations : Energy or information can be exchanged without current flow, e.g., inductive, optical, etc.

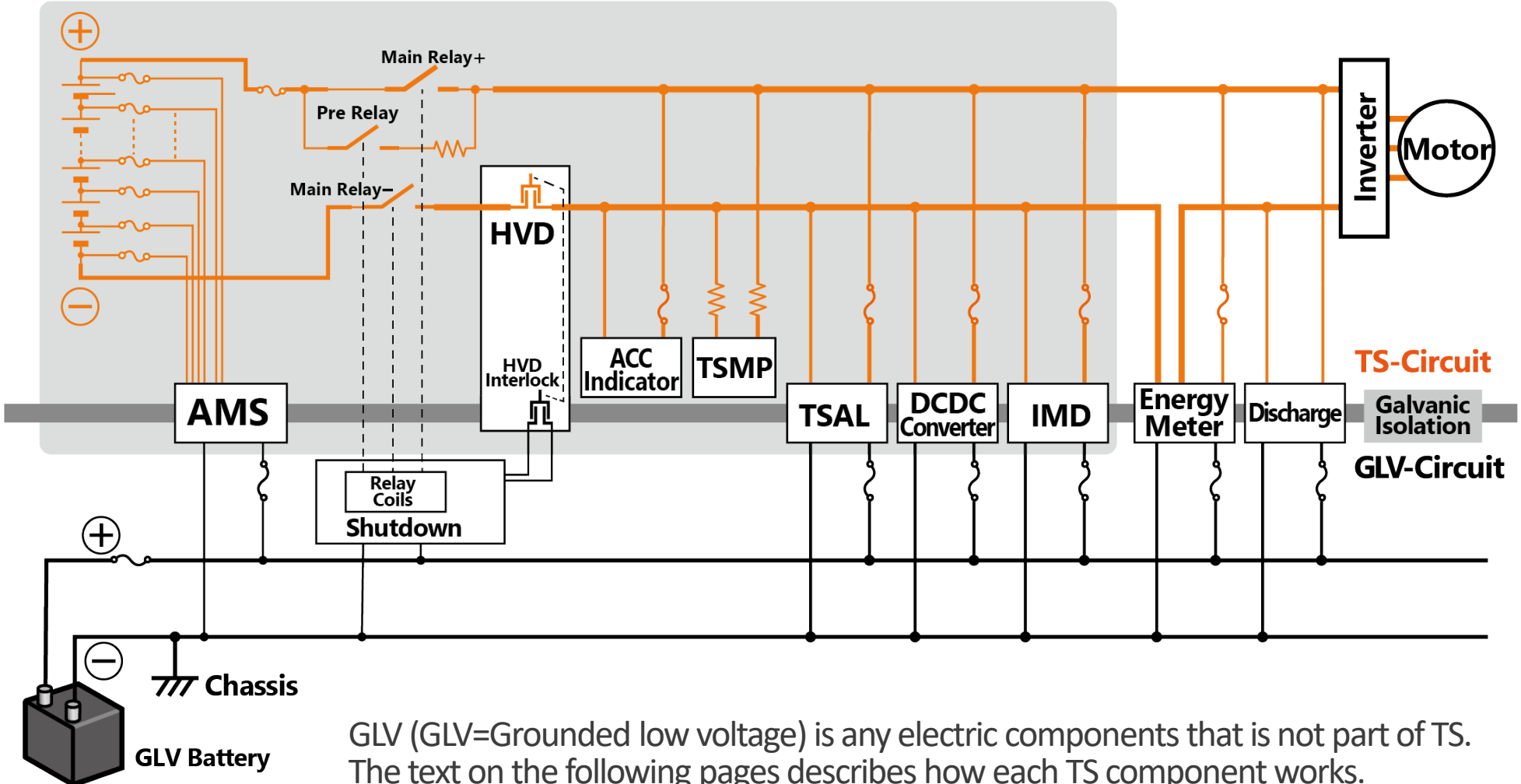

Energy transfer

Stored energy is converted into kinetic energy (=mechanical energy) for driving.
The inverter convert DC voltage and current into AC to the motor.

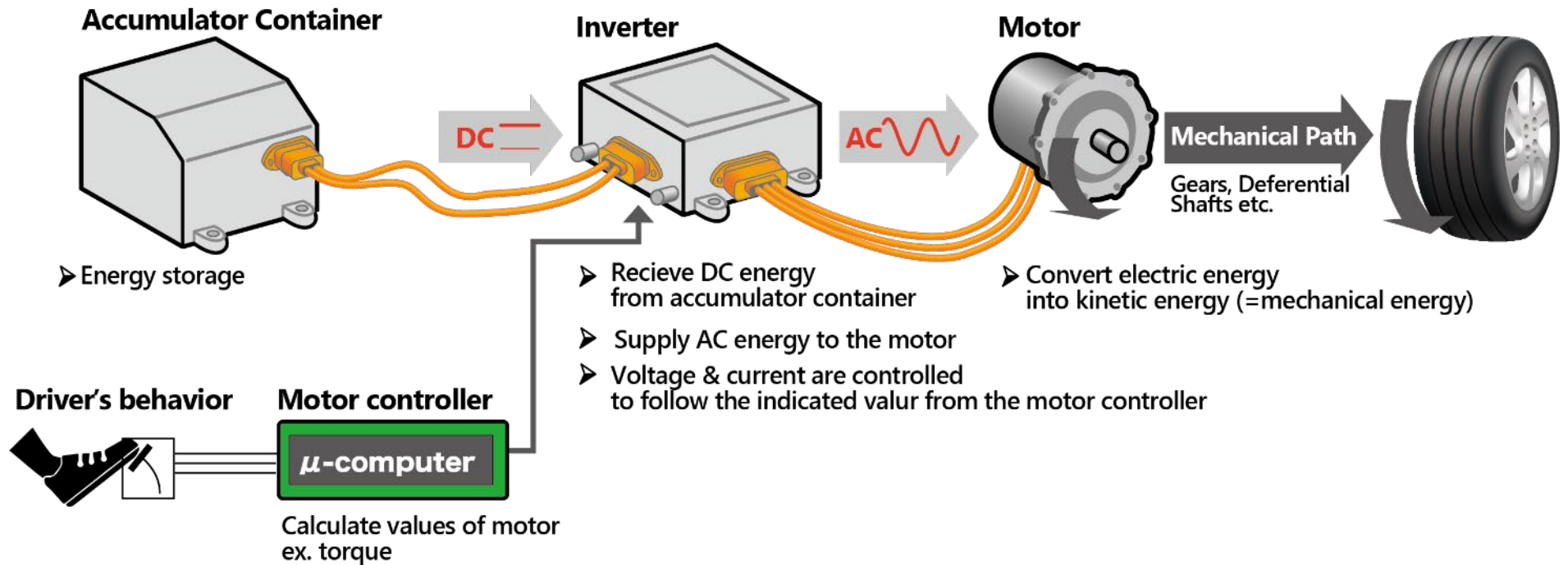

Motor

➤ Motor has both motor and generator functions.

The motor receives electrical energy and converts into kinetic energy (**Motor function**),
 , and receive kinetic energy and converts into electrical energy (**Generator function**).
 These two functions are controlled by the inverter.

Motor Electrical energy → kinetic energy = Acceleration

Generator Electrical energy ← kinetic energy = Deceleration (Regeneration)

➤ Role of inverter for motor

The inverter controls the voltage and current supplied to the motor.

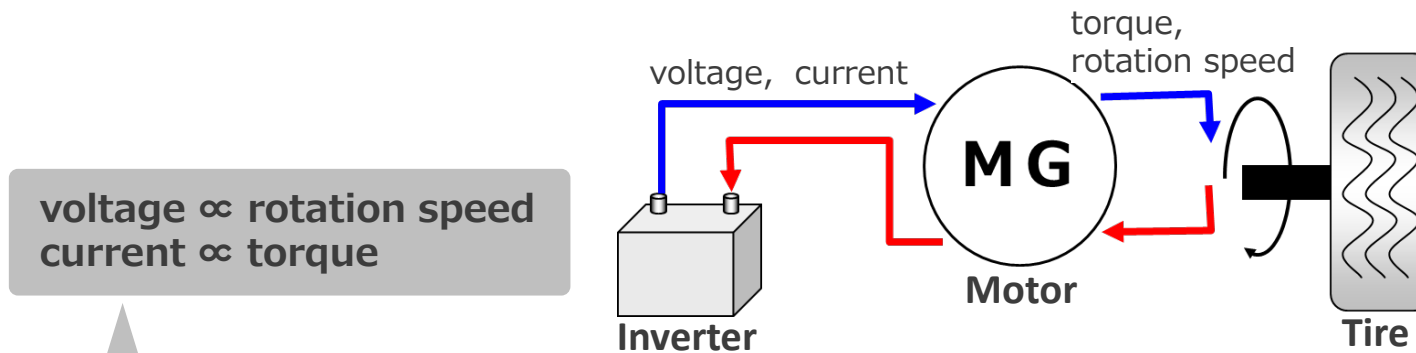

The voltage received by the motor is proportional to the rotation speed.
 (When the voltage becomes higher, the rotation speed become higher.)

The current received by the motor is proportional to the torque.
 (When the current flow become larger, the torque become larger.)

Motor :AC synchronous motor is very popular in Formula SAE

AC synchronous motor (permanent magnet rotor)

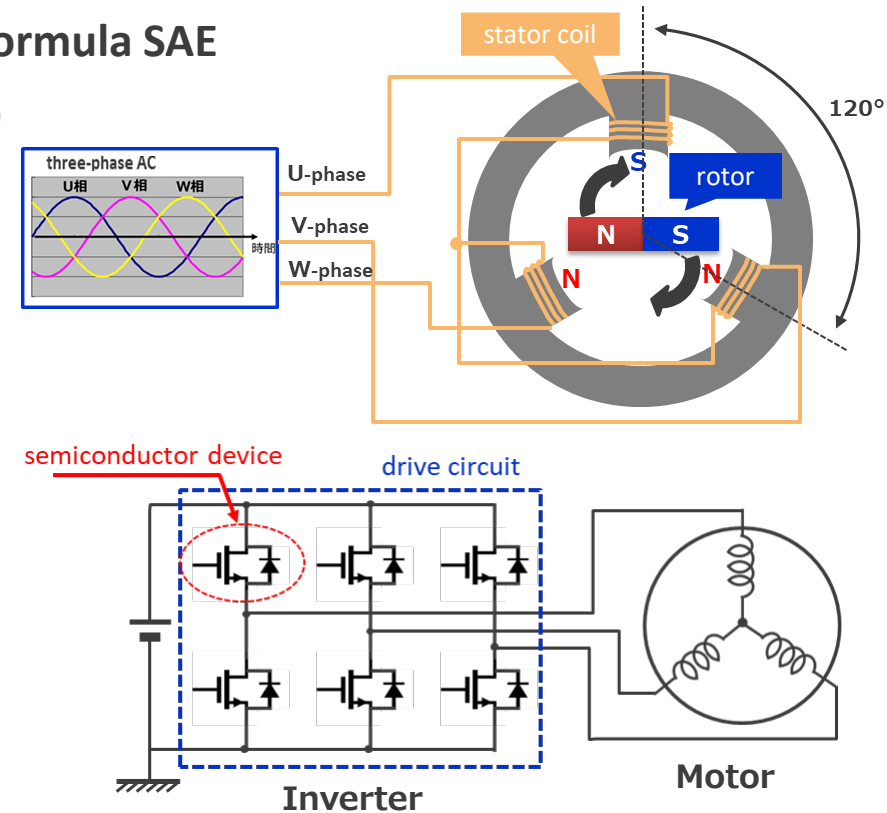
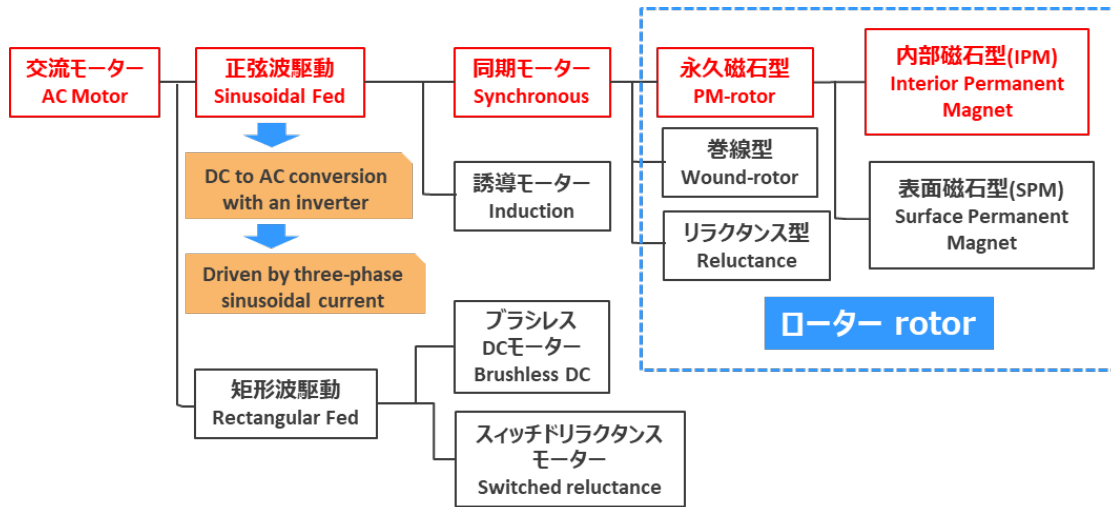

How an AC Motor works

- A rotating magnetic field is generated by applying a three-phase sinusoidal current to the stator coil.
- A motor is rotated by the repulsion/attraction between the magnets in rotor and the magnetic field generated by the current flowing through the coil.

Characteristics

- Maintenance-free
- No sparking noise
- Easy rotation speed control
- Heat release easily from the surface that is vicinity of hot coils
- A drive circuit in the inverter using a semiconductor device is required.

Inverter

The inverter converts DC to AC for the motor.

Basic operation ①

Half bridge circuit

When the two switches S1 and S2 are alternately turned ON/OFF at specified intervals, Both voltage and current are applied to the coil alternatively.

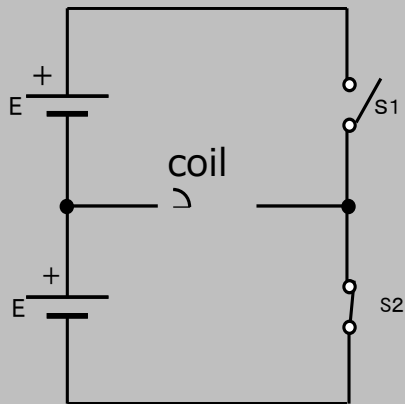

The coil in above fig. represents the motor. S1 and S2 are inside the inverter.

Control the amount of current with the width of ON and OFF (PWM control)

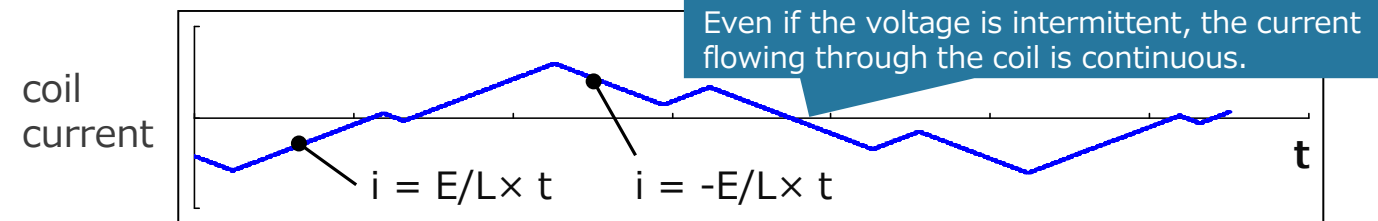
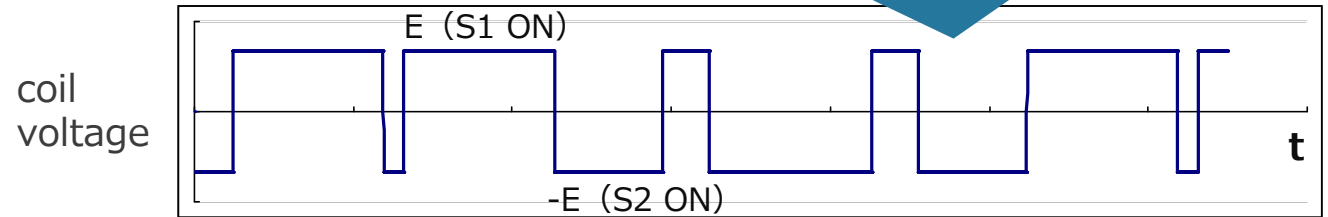

Switch S1 and S2 at higher speed

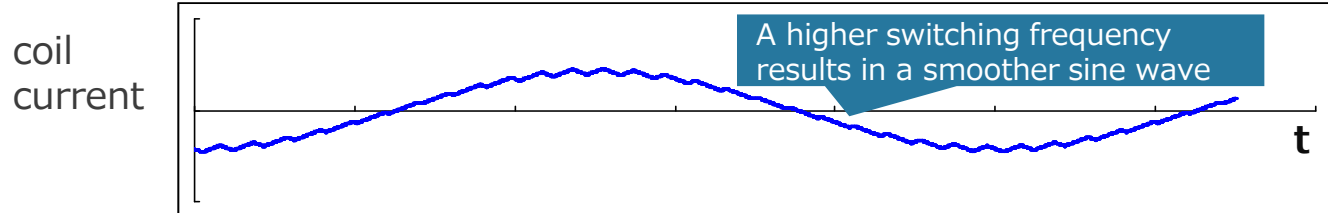
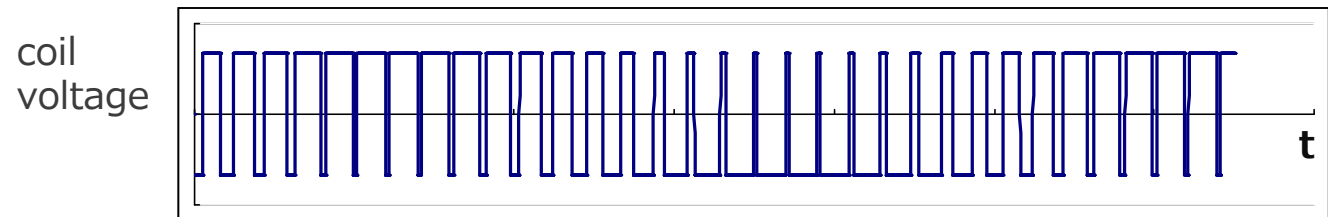

- The current flow is controlled by the ON/OFF width of switches S1 and S2. (PWM control : Pulse Width Modulation) .
- If the load is an inductance such as a coil, the current will flow continuously even if the switches are off.
- If the switch is turned on and off at a higher frequency, the current flow will be a smooth sine wave. Higher frequency is given by IGBTs (IGBT : Insulated Gate Bipolar Transistor)

Inverter

Basic operation ②

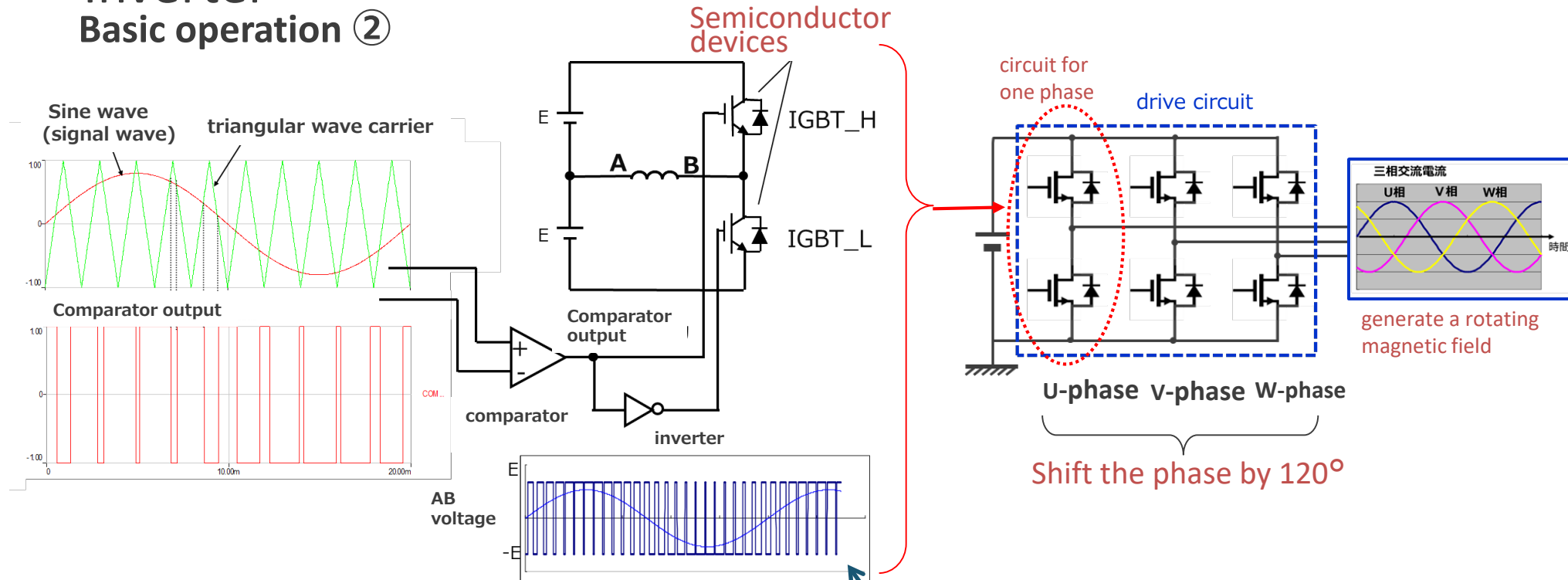

Explanation of how to apply a sine-wave “voltage” to the motor

- The Inverter converts DC voltage from accumulator container into AC voltage with high-speed switching of semi-conductors (IGBTs).
- This specific switching control is known as PWM, which is calculated by comparing sine signal and triangle wave. This “sine signal” is calculated inside the inverter. This triangle wave is based on switching frequency.
- After PWM switching, the voltage output become sine-wave. The current sine waveform is given from same PWM method.

- A 3-phase (U, V, W) sin-wave current with a phase difference of 120° is passed through each stator coil .
- The motor rotation speed is controlled by the frequency of the sine signal.
- The motor torque is controlled by the amplitude of the sine signal.

Accumulator Container (=Battery pack for Formula SAE EVs)

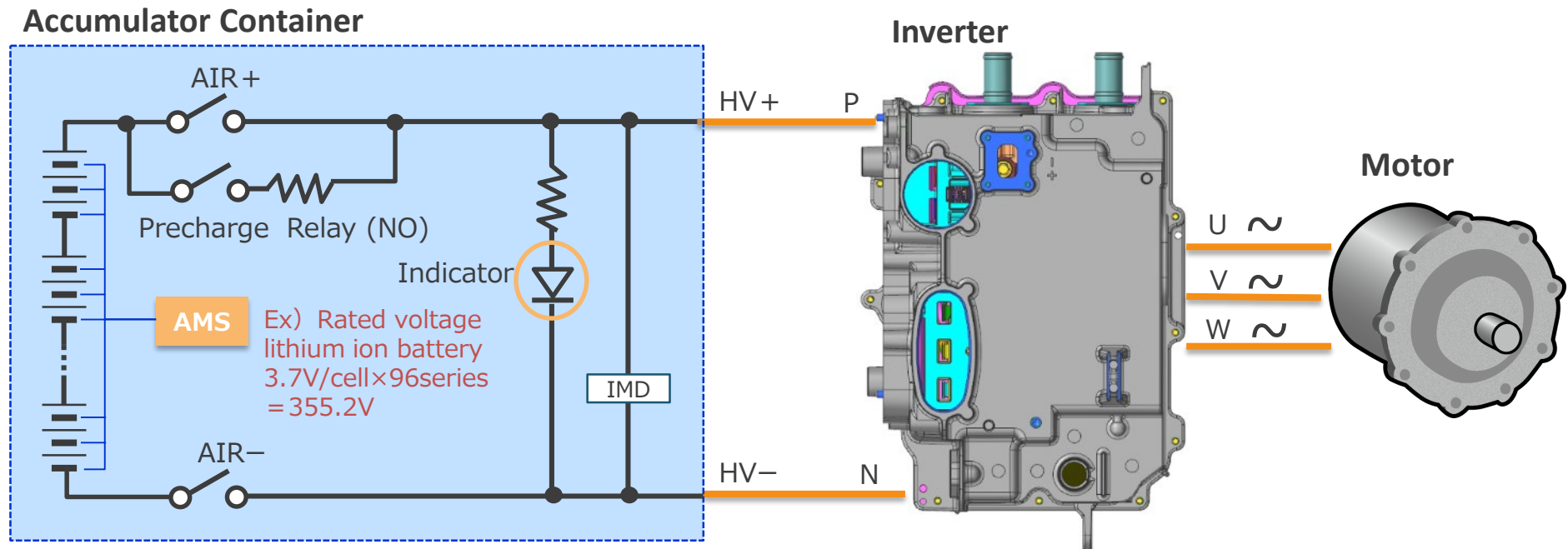

- The accumulator container (ACC) is a high-voltage power storage and supplies energy to the motor.
- The energy was stored multiple battery cells that are connected in series to generate high voltage. The cells are mainly lithium-ion batteries. The accumulator's voltage rating (=rated cell voltage x number of cells) is typically from 100V to 400V. The maximum TS voltage should be calculated from (maximum cell voltage x number of cells).
- Power relays inside the ACC connect or disconnect electrical path to the inverter. Power relays is called AIRs (AIR = accumulator isolation relay).
- Must have an indicator (or voltmeter) that lights up when the ACC is outputting high voltage. The accumulator indicator should be inside the ACC. (The circuit diagram is just for your reference.)
- The IMD inside the accumulator container in figure above is example. You can set the IMD outside the ACC.

Accumulator Container

Information required by "Formula SAE® Rules 2024"

- The structure, strength and fastening method are subject to approval during SES review.
- The ACC should be removable without disassembling, and should be charge separated from the vehicle.

Example of maintenance plug

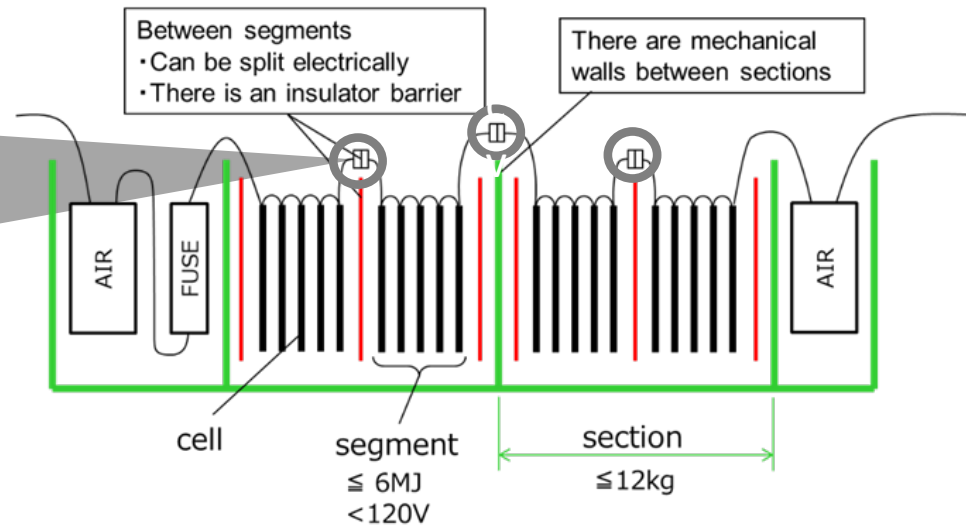
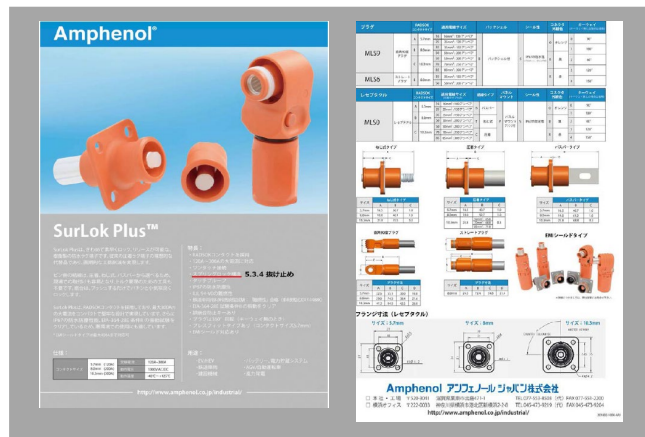

- Between segments and sections must be removable without tools.
You should use maintenance plugs having locking connectors or the like.
- See above figure for explanation of cells, segments and sections.

Lithium-ion battery cells

- Li-ion (Li^+) move between positive and negative electrode through organic electrolyte.
- Organic electrolyte has higher resistance than water-based electrolyte
The electrodes are separated by a very thin separator

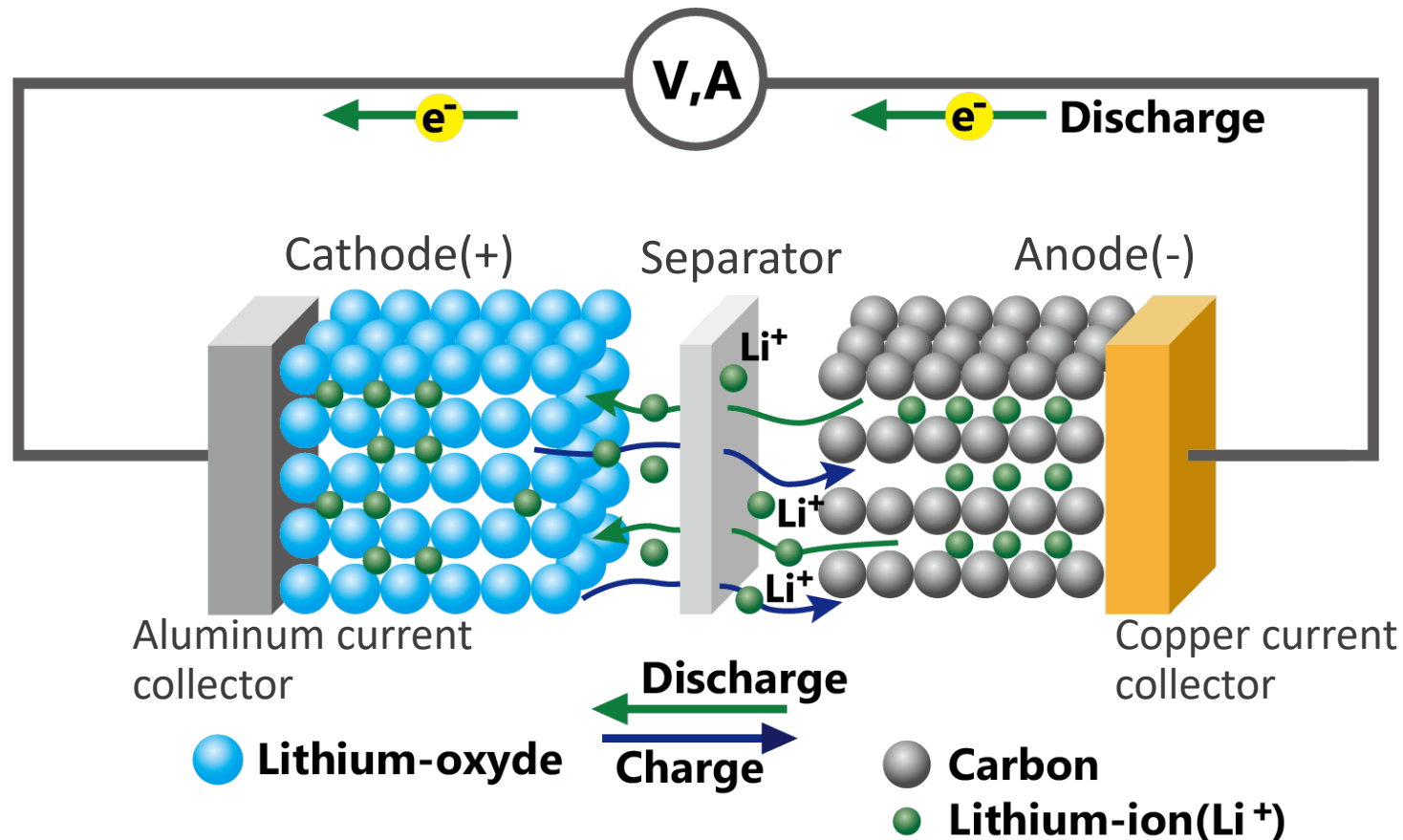

Organic electrolyte is flammable

	Solvent	Flash Point °C	Ignition Point °C
Components of electrolyte	Propylene carbonate P C	1 3 5	4 3 5
	Ethylene carbonate E C	1 5 3	4 6 5
	Diethyl carbonate D E C	2 5	4 4 5
	Ethyl methyl carbonate E M C	1 5 3	4 6 5
	Dimethyl carbonate D M C	1 8	4 5 8
	Gasoline	- 4 0	3 0 0
	Kerosene	4 0 ~ 7 5	2 4 0

Ignition mechanism of lithium-ion batteries

High temperatures lead to oxidation of the electrolyte and generation of heat. Overheating leads to **thermal runaway** and ignition.

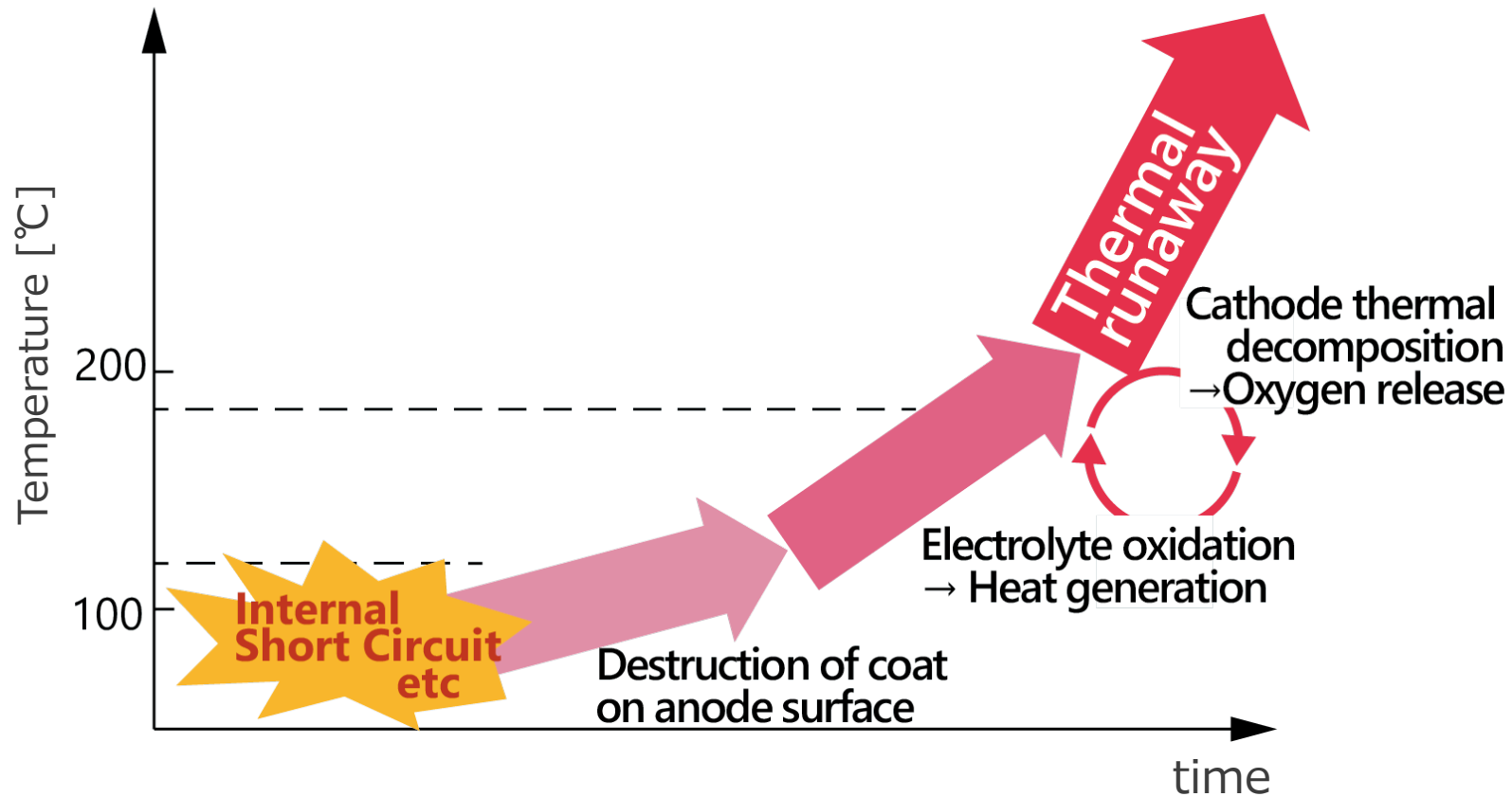

The case of a pouch cell is very thin, so a short circuit will quickly catch fire.

The Internal resistant of cells is very low ($\leq 1\text{m Ohm}$).

If you short circuit the cells, the current flow is extremely high. It can cause firing.



(The photo above shows an example of an “overcharged” cell swelling and then bursting)

写真引用元 : GWL, “Dangerous vs. Safe batteries, Explosion and fire test!”, <https://www.youtube.com/watch?v=Qzt9RZ0FQyM>

How to deal with damaged batteries

Prepare fire extinguishers and personal protective equipment.

Lithium-ion's electrolyte is flammable.

Electrolyte has a risk of "chemical burns" and poisoning.

Flammable



Toxic

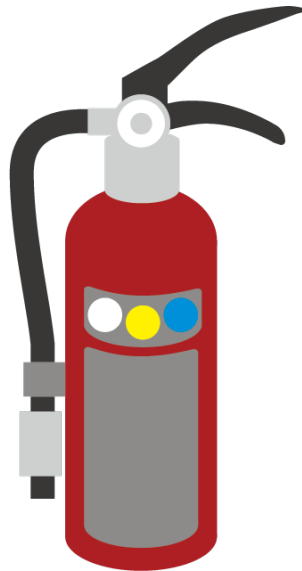

personal protective equipment (PPE)



Goggles
for eye protection



Gas mask
for organic gases



Non-permeable
gloves

HVD (High Voltage Disconnect)

HVD is a device for disconnecting one or both poles of the accumulator container.

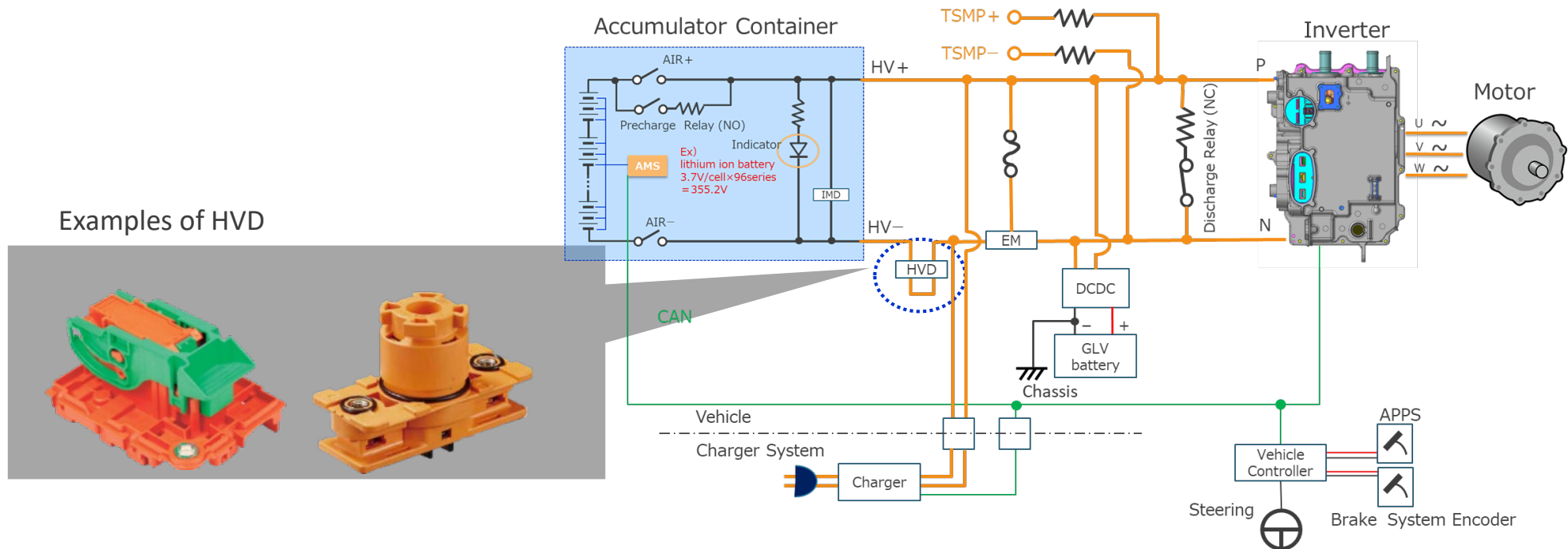

Information required by "Formula SAE® Rules 2024"

- Must be directly accessible by hand and operable in 10 seconds or less by an untrained person without removing any bodywork or obstruction or using tools
Must be directly operated (remote control mechanism is not permitted)
- Must be easily visible when standing behind the vehicle.

Power Relay

Power relays are used to connect or disconnect the positive and negative batteries current path. Connect or disconnect signals are come from host controller or shutdown circuit.

Power Relay example

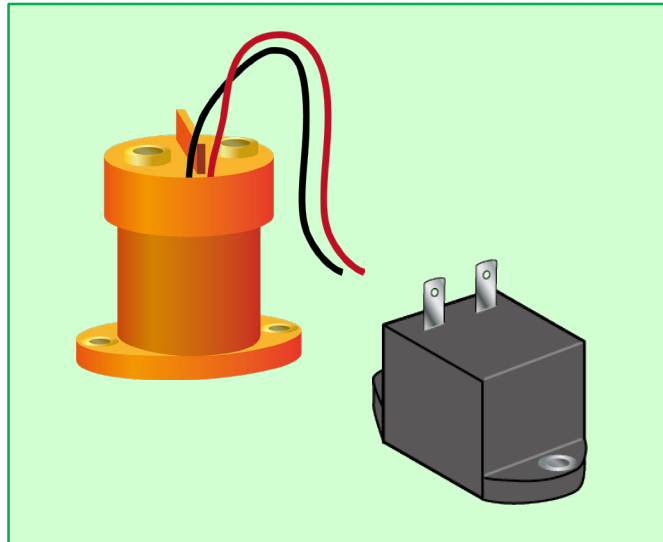

Accumulator Container

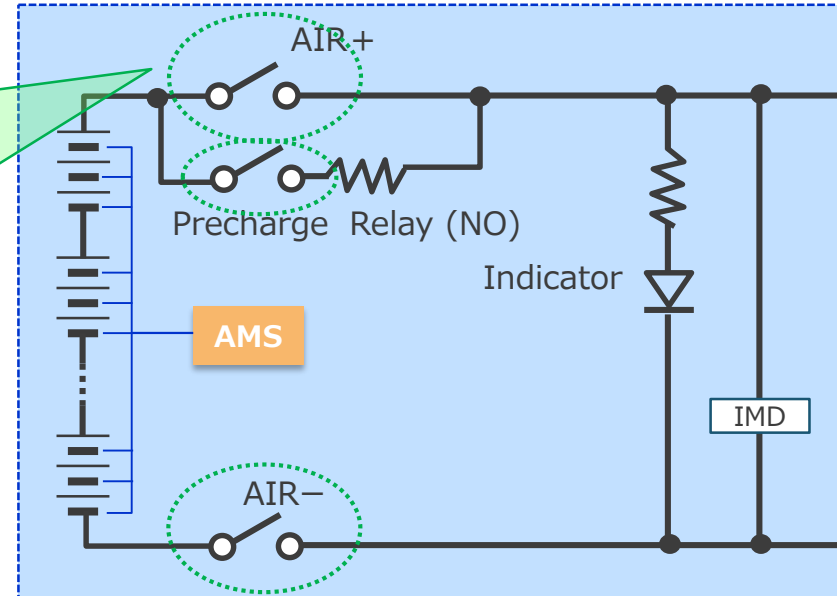

Information required by "Formula SAE® Rules 2024"

- Power relays are both AIRs and pre-charge relay. Those must be mechanical relays and normally open type.
- The AIRs must open both the positive and negative poles of the ACC.

Power cable

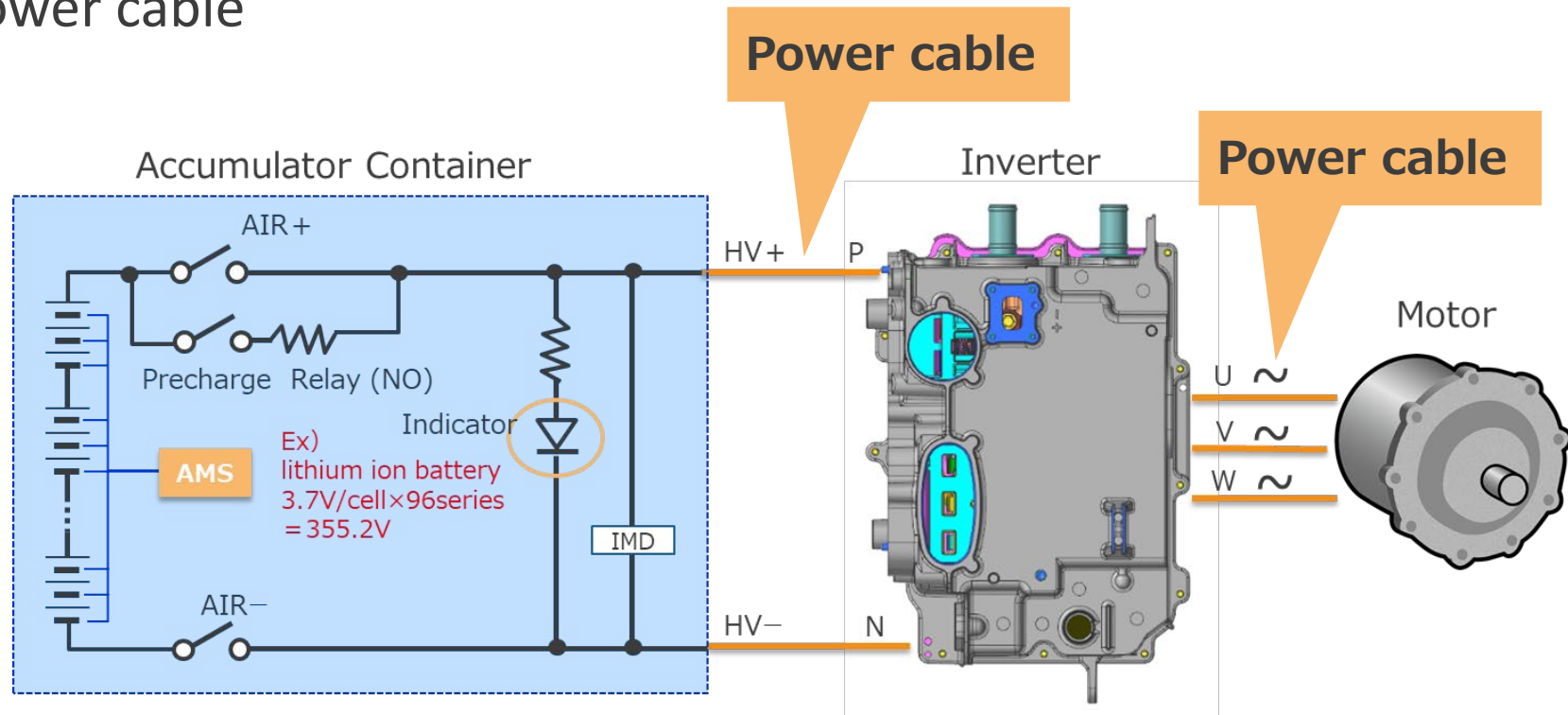

- TS wiring (Power Cable) connecting high voltage components (Accumulator, Inverter, Motor, etc.) must use orange cable or conduit, and must be marked on it (cross section area, temperature and voltage rating) .
- No orange cables must be used in the wiring harnesses of 12V and 24V power circuits.
- Bolted electrical connections in the high current path of the TS must include a positive locking feature to prevent unintentional loosening.

IMD (Insulation Monitoring Device)

An insulation monitoring device is required for EVs.

The IMD must monitor the Tractive System for an **isolation failure** and a **failure of the IMD function**.



ISOMETER® IR155-3203/IR155-3204

Function

The ISOMETER® iso-F1 IR155-3203/-3204 generates a pulsed measuring voltage, which is superimposed on the IT system via terminals L+/L- and E/KE. The latest measured insulation condition is available as a pulse-width-modulated (PWM) signal at terminals M_{HS} (for IR155-3204) or M_{LS} (for IR155-3203). The connection between the terminals E/KE and the chassis ground (▶ KI.31) is continuously monitored. Therefore it is necessary to install two separated conductors from the terminals E or KE to chassis ground.

Once power is switched on, the device performs an initialisation and starts the system state (SST) measurement. The ISOMETER® provides the first estimated insulation resistance during a maximum time of 2 seconds. The DCP measurement (▶ continuous measurement method) starts subsequently. Faults in the connecting wires or functional faults will be automatically recognised and signalled.

During operation, a self test is carried out automatically every five minutes. The interfaces will not be influenced by these self tests.



Information required by "Formula SAE® Rules 2024"

- The IMD must be a Bender ISOMETER® IR155-3203 or IR155-3204 or equivalent IMD approved for automotive use.
- The response value of the IMD must be set to **500 Ohm / Volt or higher**, related to the maximum Tractive System operation voltage.
- If the IMD detects isolation failure or a failure in the IMD itself, it must open the shutdown circuit and turn on the IMD indicator to the driver.

AMS (Accumulator management System)

- AMS monitors the accumulator container and commands to open the shutdown circuit in the event of an abnormality
- AMS is called BMS (Battery management system), Battery ECU (Battery ECU), Cell monitoring system, etc.
- AMS monitors all cell voltages and the representative temperatures whether in the normal range of operation.
- AMS opens the shutdown circuit in case of trouble when cannot monitor cell voltages or cell-temperatures.

In AMS, the TS circuit is galvanically isolated from the GLV circuit.
Isolation structure is depended on the model and its circuit method.

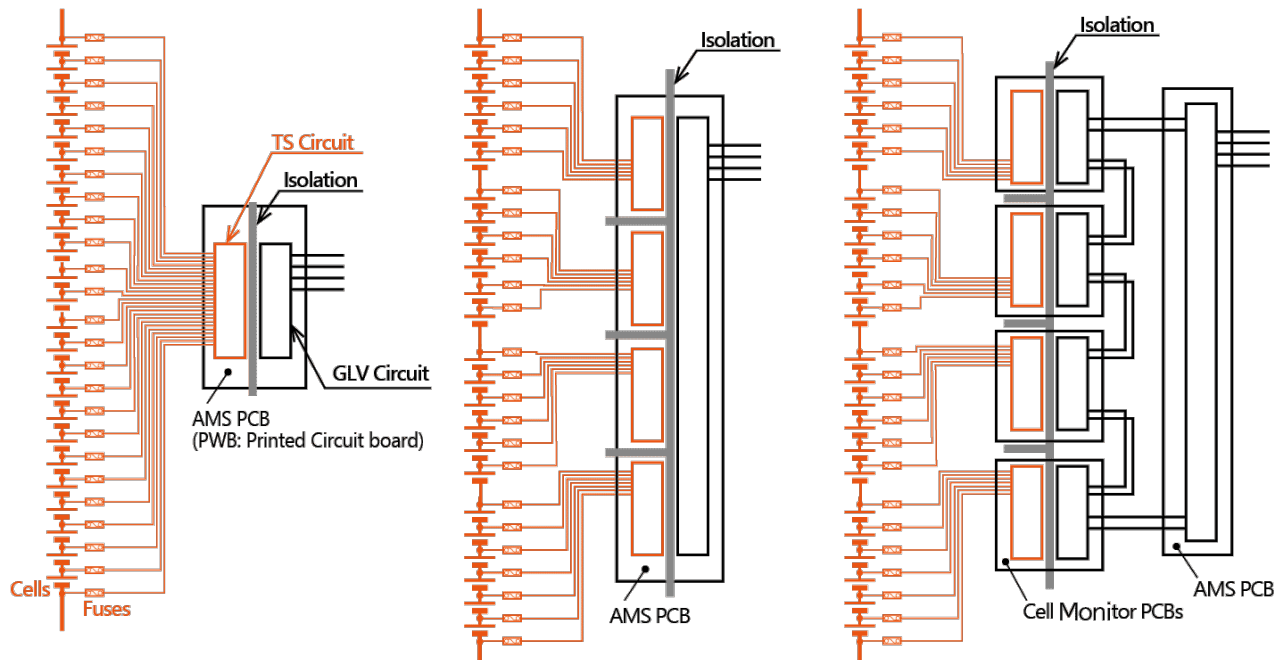

Contents

1. Low Voltage Electricity Hazard (750V DC or less, 600V AC or less)
2. Basic knowledge of high-voltage components in JSAE Formula EVs
- 3. Basic knowledge of personal protective equipment and tools**
4. Electric work on high-voltage systems
5. Trouble in the past
6. First aid in the case of incident and fire extinguishing
7. Safety Precautions for Working with EVs

Personal protective equipment(PPE)

The role of PPE is to shield the source of the hazard by attaching it to the body.

Use protective equipment appropriate to the source of the hazard.

Insulating protective equipment and insulating tools are also used for high voltage work.

PPE



In general, PPE does not include appropriate clothing.

Shield against hazard



Example of Hazard on HV work

High-voltage



Spark



Lithium-ion cells

Toxic



Flammable



PPE: Personal protective equipment

The PPEs are to shield the human body and the high-voltage components



Safety glasses

Eye protection from sparks, substance



HV insulating gloves

Voltage specs are determined.

The specified voltage range needs to exceed the maximum voltage of TS.

As stated in Formula SAE® Rules 2024, HV insulating gloves within 12 months of the test date are required.



Protective shoes with insulation

Recommended PPE in JSAE 2022 competition,
And not written in the SAE rules.

In general, voltage is not standardized by law



Pre-use inspection of HV insulating gloves

Check! before every operation to ensure the safety

① Visible Check

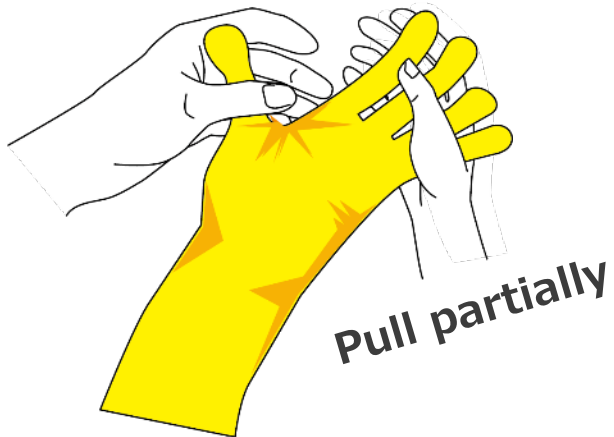

Surface :
Cracks, Breaks
Adhesions of foreign substances, moisture

② Pinhole Inspection

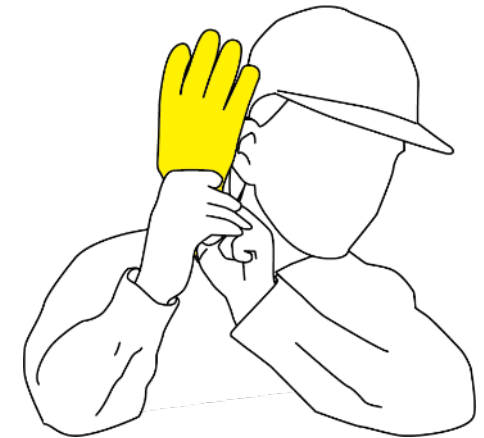
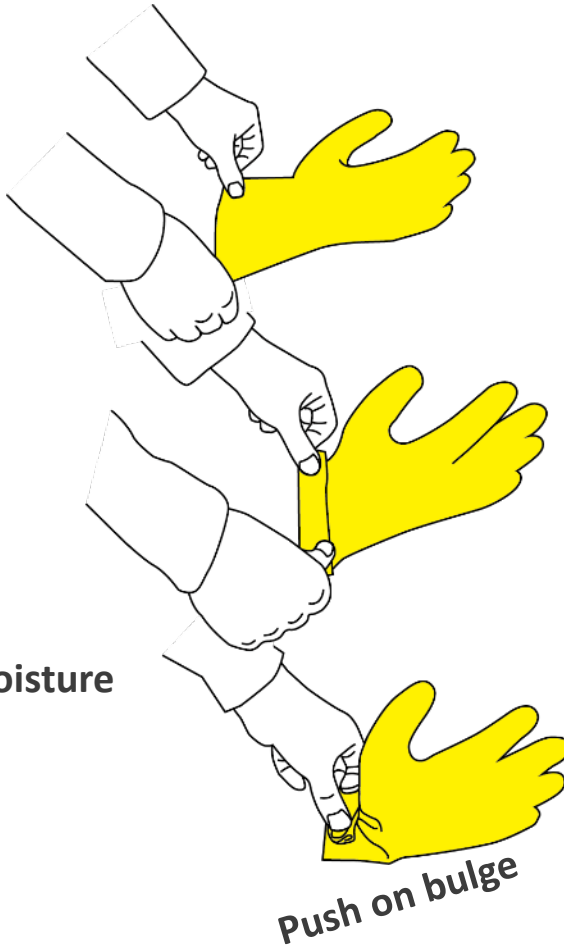

Check the sound of leaking air

Insulation sheet

Made of rubber or resin (PVC, PU etc.)

Before disassembling accumulator container, work space should be covered by insulation sheet

Insulation specs according to DIN EN61112 (VDE 0682-511),



➤ Cover adjacent live components

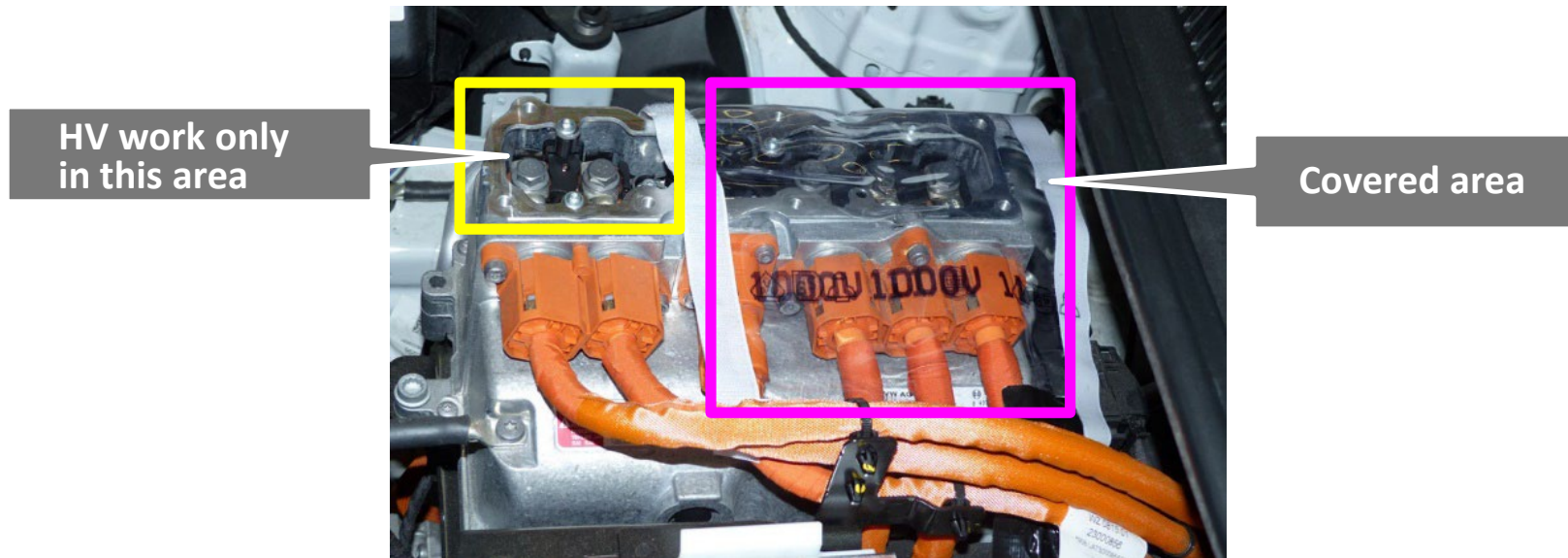

Electrical test equipment

Equipment is used to check whether components or wiring are live or not.

Multimeter



Check "0V" before work



Protected by sleeve from HV touch
CAT III, 600V

Insulation resistance tester (Megger)

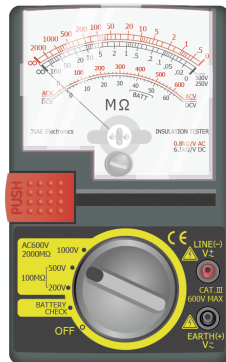

Measure resistance at high voltages to verify insulation.

- Measurement-voltage is Range is $\geq 500V$
Excessive voltage will destroy components,
too low voltage will not be detected failure or weakness
- Wrong measurement point will damage the vehicle
ex. Apply 500V to LV components directly

Be careful of electric shock due to the high voltage generated when measuring insulation resistance.

Usage of insulation resistance tester

Insulation check before and after work

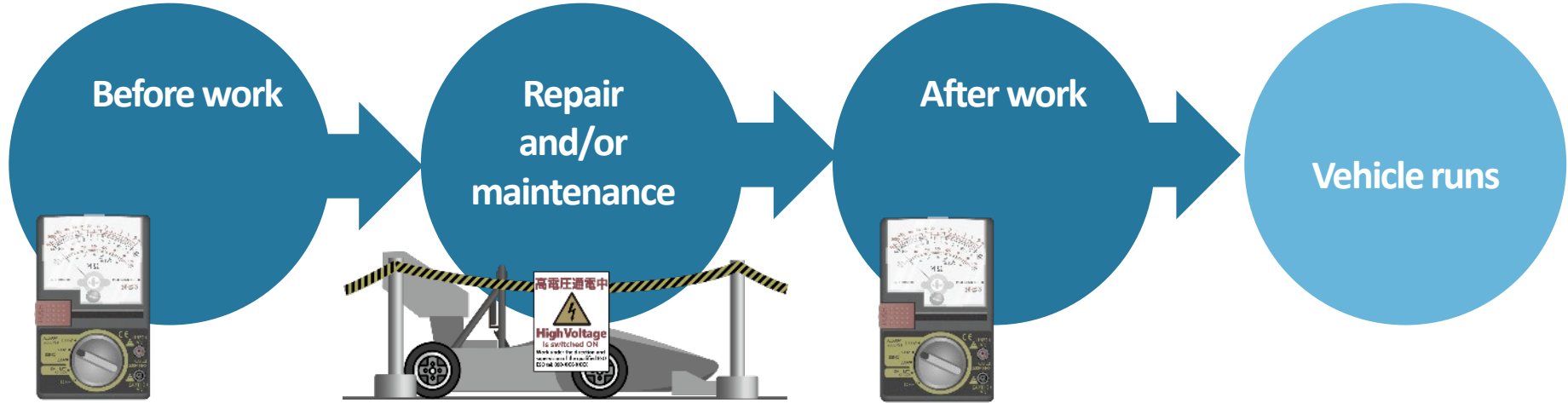

In the event of crush

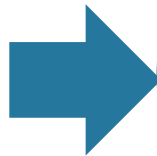
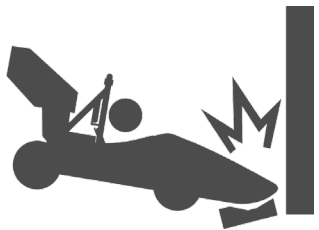

Disconnect TSMS,HVD



Use probe with protected probe tips to measure TSMPs

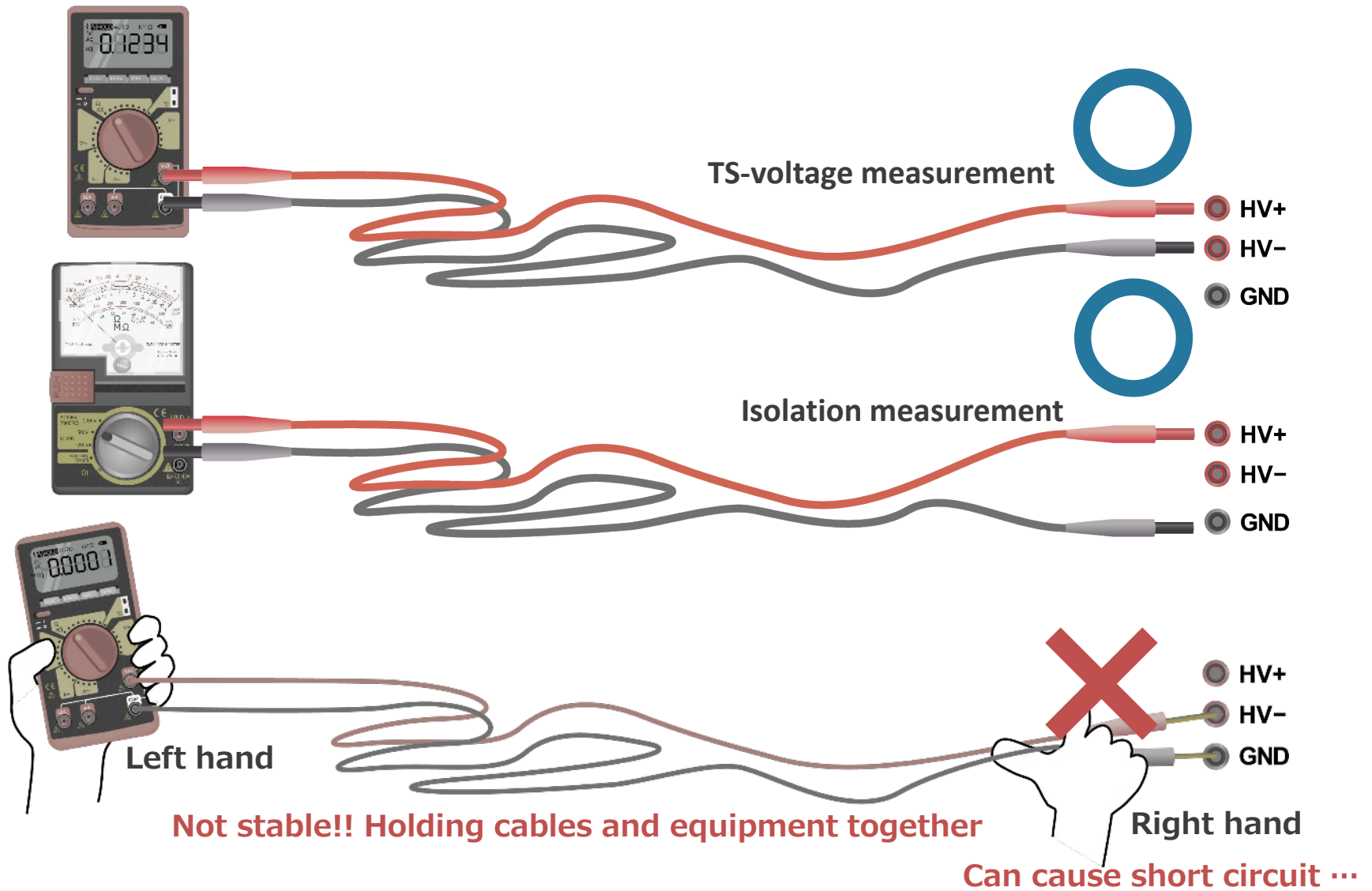

Insulation monitoring device inspection (refer SAE Rules, IN.4.4.1)

The figure below is example of a test resistor for connect between TSMP and GLVMP.

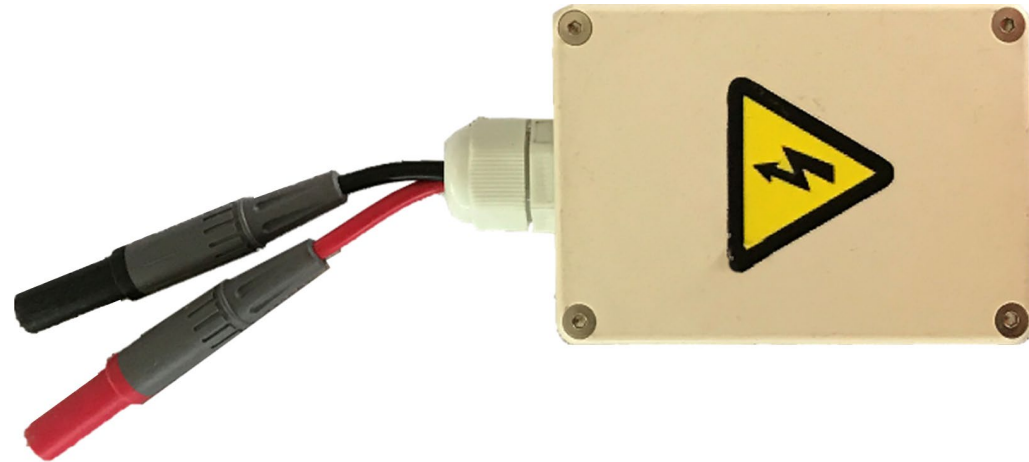

Other safety equipment

Insulated tools



Mistakes can be made in the work

Prevent short circuits due to falling or accidental contact of tools

Use HV insulating gloves when using insulated tools

Before using insulated tools, make sure that the insulation coating is not damaged.

There is no Japanese standard for insulated tools, which conform to international standards.

Insulators are made of polyvinyl chloride or fluorine resin.



Add insulation tape onto normal tool

If insulated tools cannot be prepared unfortunately, cover the metal parts with insulation tape.

Other safety equipment

Insulation tape

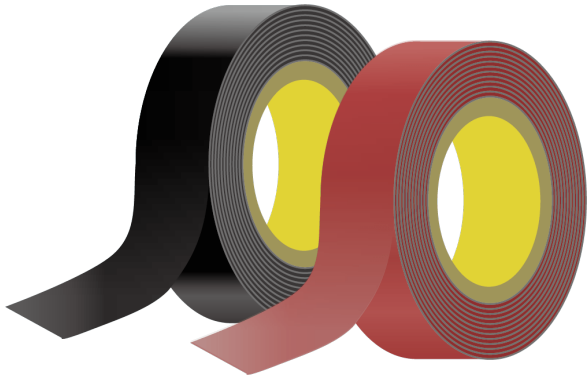

High insulation performance

Used to bunding cables and cover the end of terminal

Not used alone mechanical strength are required

Mostly made of polyvinyl chloride

Rubber-rubber, acetate-based (cloth tape), and others are also available.

Specialty materials are heat-resistant glass fiber and moisture-resistant, high-strength butyl rubber, which is resistant to moisture and high strength

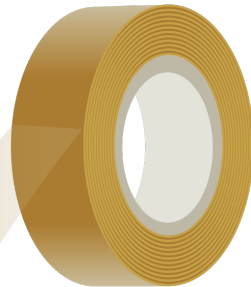

❌ Do not confuse insulation tape with normal cellophane tape.
Do not use cellophane tape, masking tape, or packing tape for insulation

Summary Basic knowledge of personal protective equipment and tools

- **Wear protective equipment when working with high-voltage**

- **HV insulating gloves should be checked for scratches, foreign objects, and pinholes on the surface before use.**

- **Check “0V” and "insulation resistance" using a multimeter and an insulation resistance tester before work.**

Contents

1. Low Voltage Electricity Hazard (750V DC or less, 600V AC or less)
2. Basic knowledge of high-voltage components in JSAE Formula EVs
3. Basic knowledge of personal protective equipment and tools
- 4. Electric work on high-voltage systems**
5. Trouble in the past
6. First aid in the case of incident and fire extinguishing
7. Safety in working with EVs

High-voltage work different degree of skills

ESOs should determine the work level of their members.

Work by unskilled members is dangerous.

High-voltage work without power disconnection requires skills comparable to ESO's.

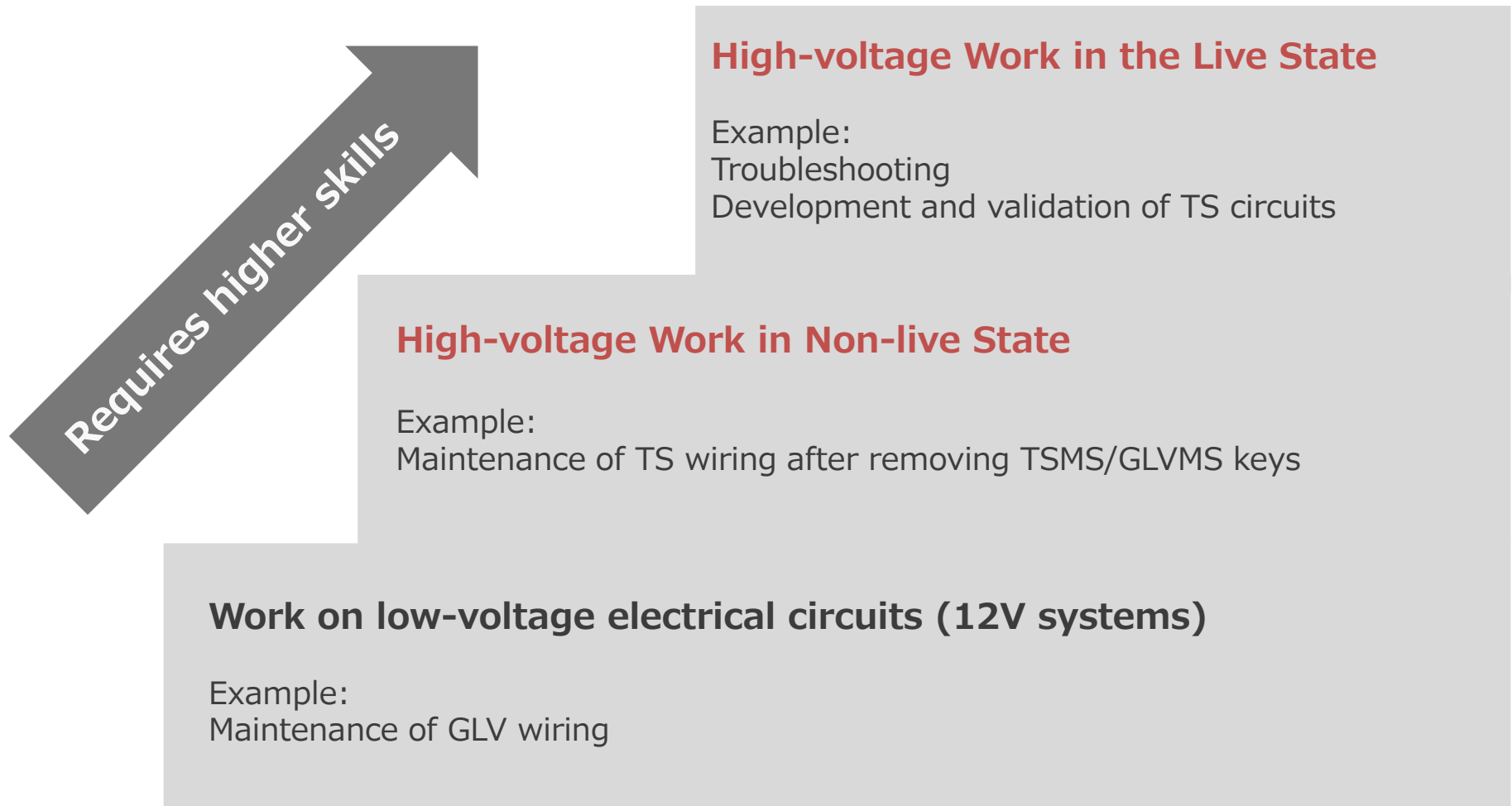

Safe Work flow

Good preparation is essential for safe work.

Work on vehicles and accumulator containers are shown as examples below

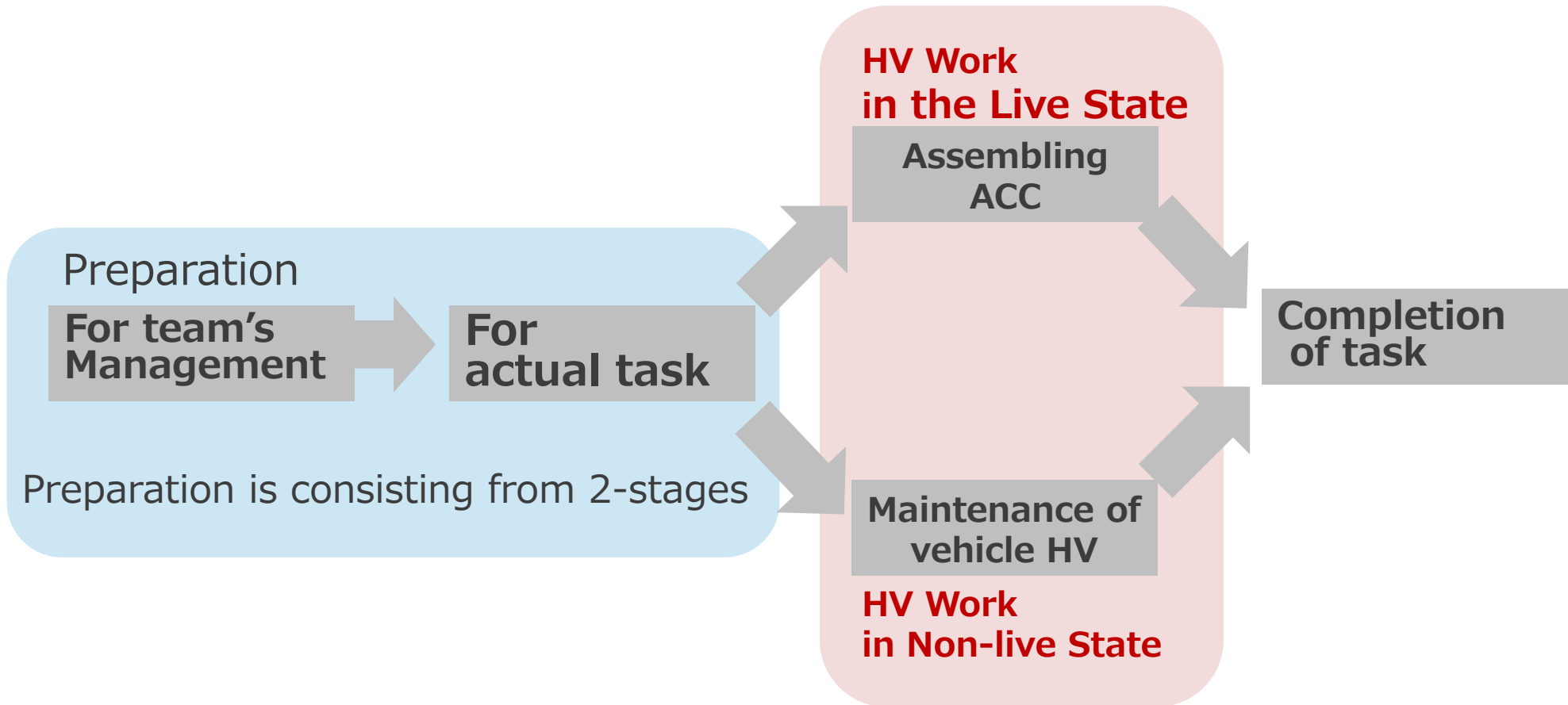

Preparations

**For team's
Management**



**For
actual task**



More intended to management

Members must be provided with appropriate information in advance

- Provide high-voltage safety training & accident cases
- Create work rules
 - Wearing protective equipment
 - Protective covers to live parts
 - "Do not work alone."
- Foster skillful ESOs and members for high-voltage work

Share procedure and information Distributable tasks between members

- Create written procedure
- Members need to understand entire system
 - Drawings : Wire-harness, Diagram
 - Actual products and components
- Share **possible info of risks** with members

Safe Work flow

Good preparation is essential for safe work.

Work on vehicles and accumulator containers are shown as examples below

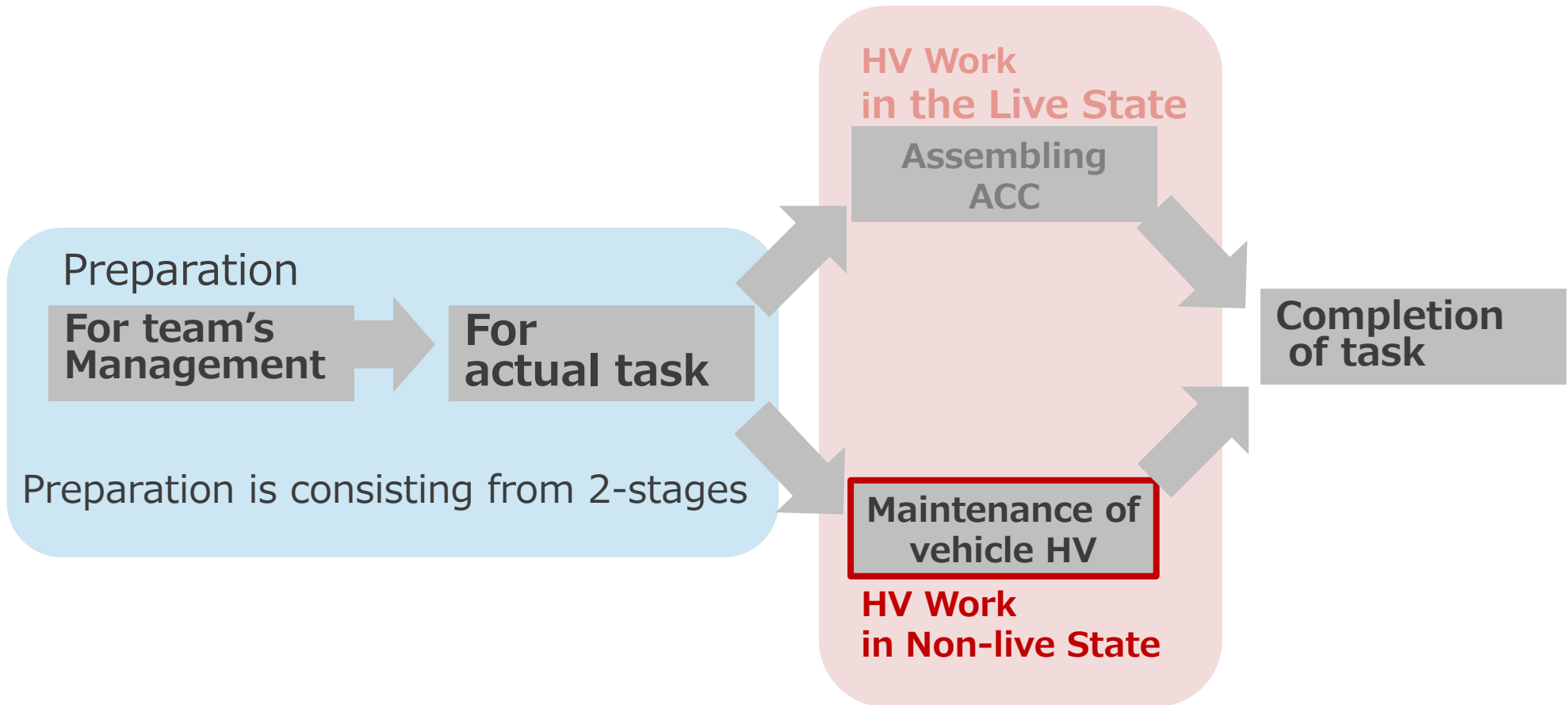

Preparations

For actual task

- Checking and wearing PPE

Safety glasses



HV insulating gloves



Protective shoes with insulation



- Metal items should be removed from the body and clothing, to avoid short circuit of HV

Pencils, necklaces
Scales

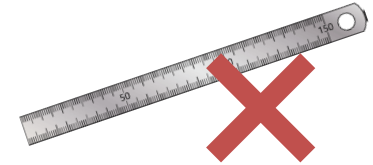

- Safeguarding work area

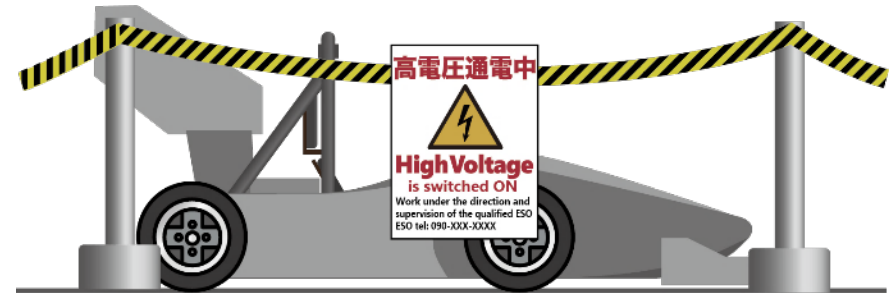

During tasks maintenance of vehicle HV

Unlock power

- Pull out TSMS & GLVMS (Lockout)
- Secure against being switched on again (Tagout)



Photo shows lockable MS

- Remove HVD with HV insulating gloves ※ 1 写真



- Dummy HVD is useful prevent dust/water and re-switching on
- Disconnect 12V on-board battery (=GLV battery)

Determine absence of voltage in the multiple ways

- Voltage indicator on accumulator container and/or TSAL=Green (1st check)
- Check with a multimeter that **TSMP voltage is 0V (2nd check)**

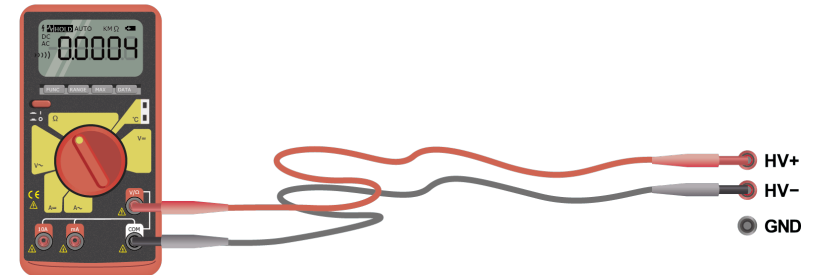

- Check with an **insulation resistance tester** that the value is greater than or equal to predetermined value.

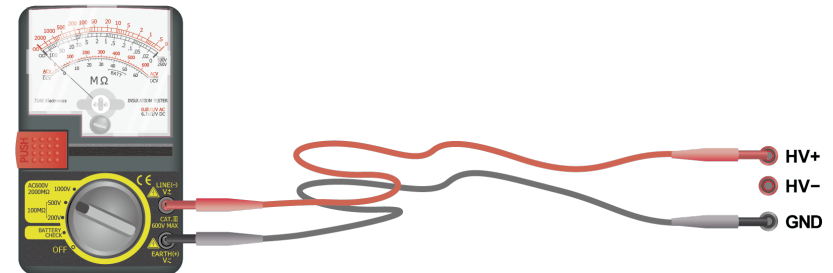

※ 1 写真引用元 : OUTLANDER PHEV Model year: 2016 - 2020

https://www.mitsubishi-motors.com/en/RS/oceania/OUTLANDER_PHEV/pdf/GGW-ANRS-EN02.pdf

Notice on work

➤ Check “0V” with a multimeter as necessary

Ex: When removing the input terminals of an inverter, measure the voltage in advance.

• Purpose of “0V” check

a) Verify that the stored energy is zero and that there is no risk of electric.

b) To confirm that the system is as you thought it would be.

*Even after checking “0V”, HV insulating gloves should be worn at work.



➤ Insulate removed connectors and terminals.

Insulate them so that they cannot be easily removed.

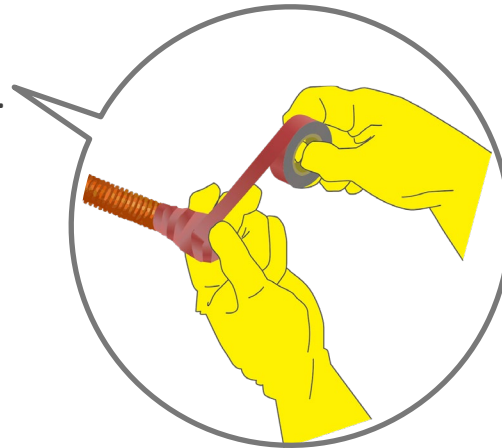

➤ Use a torque wrench to install the terminals of the high-current path

➤ At the end of the work on the vehicle,

check the TSMP for 0 V and measure the insulation resistance
to make sure it is safe to work on the vehicle.

Work in an accumulator container

HV work should be done after de-emerging HV components

However, if it is necessary to work on live HV components, **cover the live parts**

This section shows work in an accumulator container that HV voltage cannot be switched off.

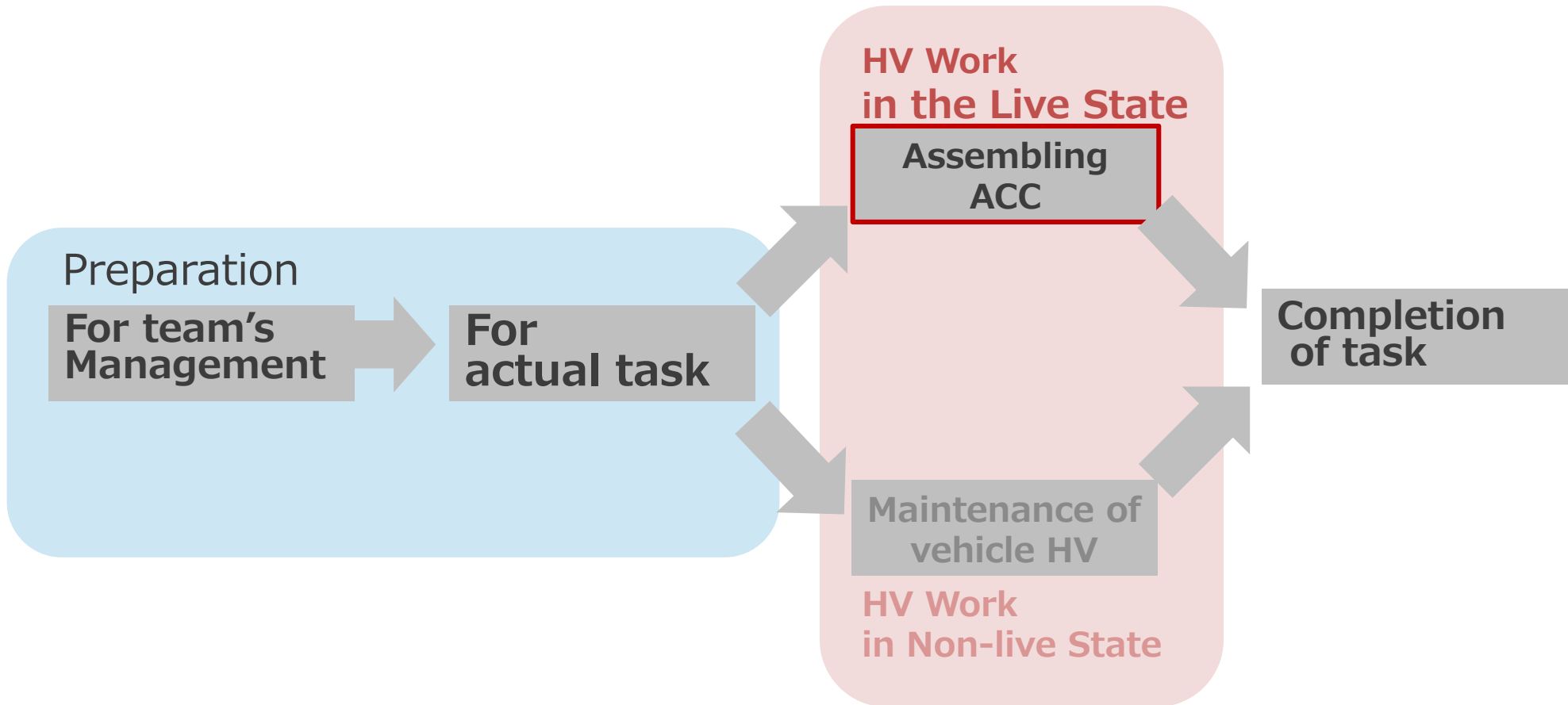

HV Work in Live State

- Wear suitable PPE (same as Non-live state)

- **Reduce the voltage level to be worked**
e.g., Removing maintenance-plugging to split between segments

- **Cover adjacent live components**

Insulator means transparent resin plates, cover cloths according to DIN EN 61112 etc.

Pre-cautions during installation of insulators

- Insulators must be installed starting from the front of the operator and removed from the far side

- **Action must be one by one**
When installing insulators with multiple workers,
 - one worker must do the work at a time,
 - other workers who must not work at the same time must stand by and monitor the workers installing the insulators to ensure that they are not in danger of receiving an electric shock.

- Secure the insulator so that it will not come off.

Example of High-voltage Work in the Live State

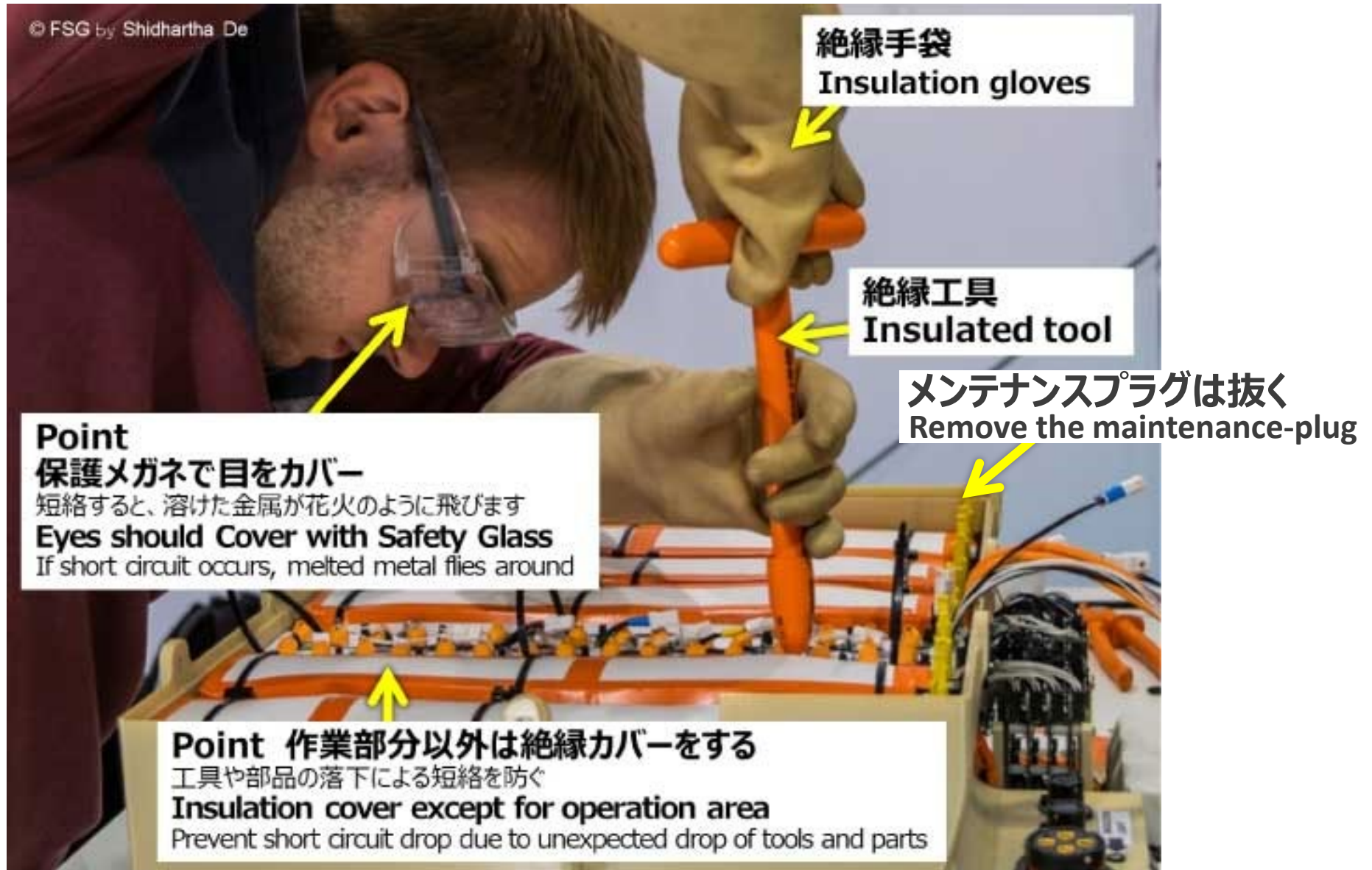

Example of High-voltage Work in the Live State

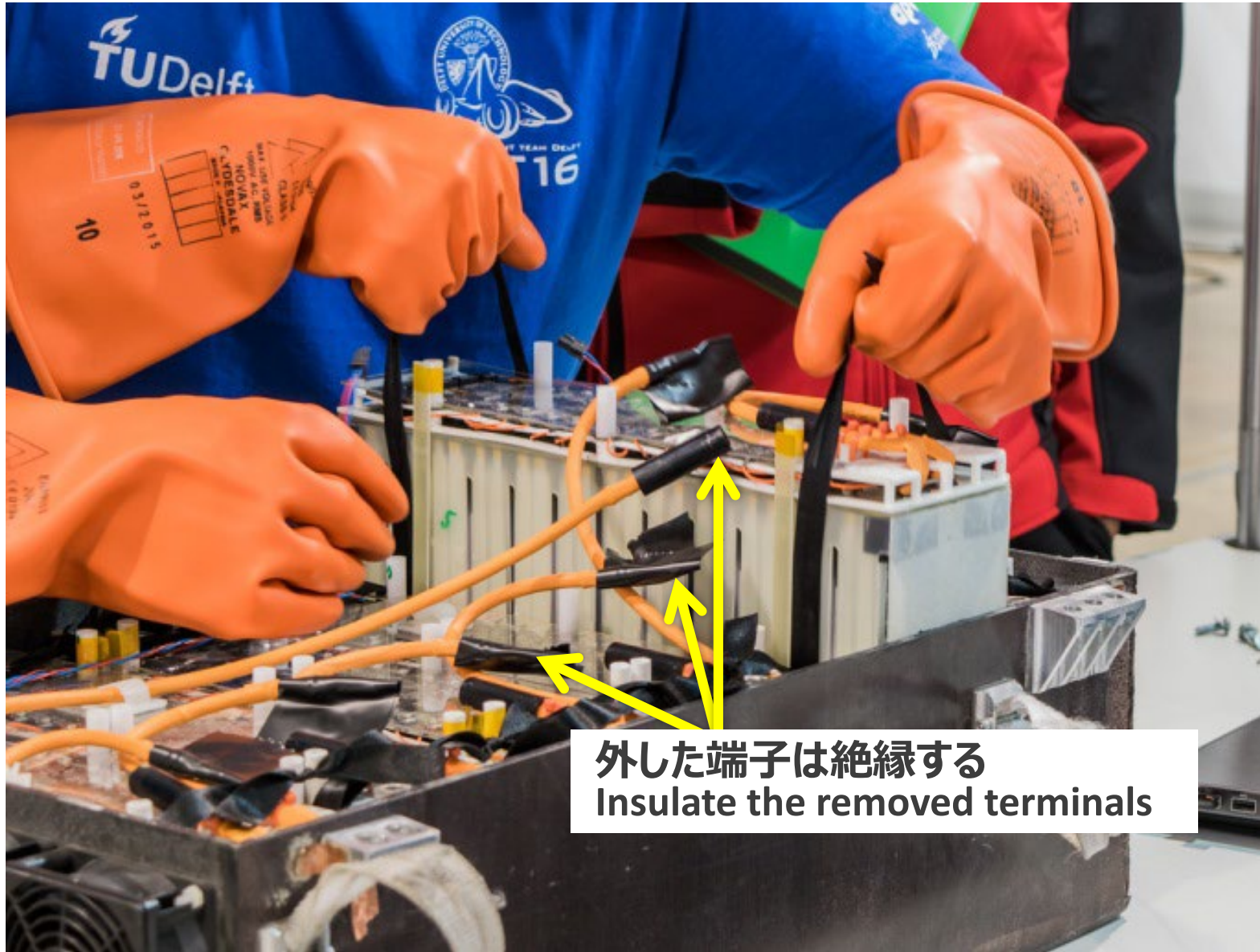

Charging accumulator container

Charging lithium-ion batteries requires special management due to risks about fire and other accidents.

During the competition, charging of an accumulator container is a high-voltage work and requires the presence of the ESO.

- Prepare a written charging procedure in advance
- Procedures should include stopping charge on the way, and smoke/fire ignition

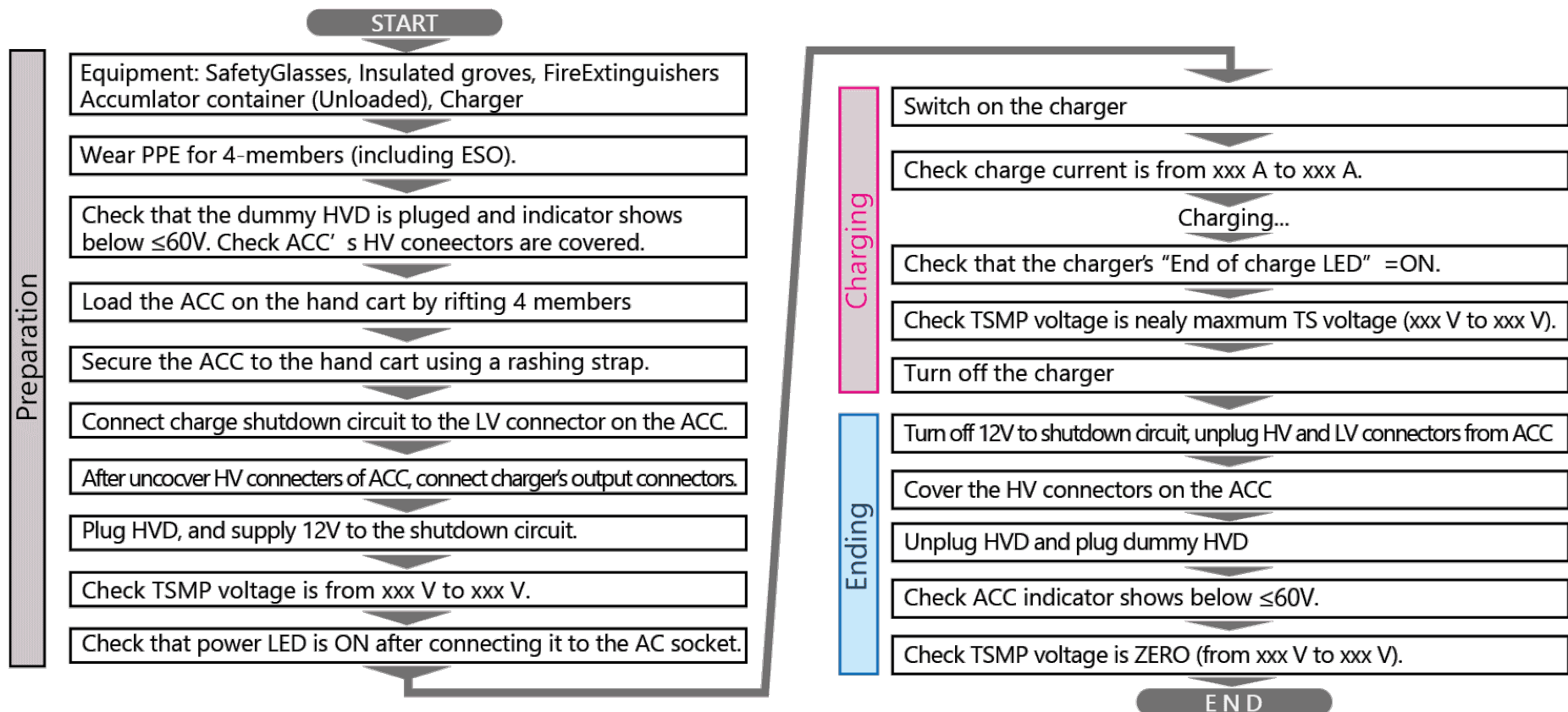

Example of normal charging procedure

Examples of team's rules

Members has different of skills normally

Simple rules could be understood clearly and improve the entire level of teams.

Items below shows example of know-how about HV work **Start with what you can do !**

DO'S

- DO plan and discuss procedure and risks
- Do isolate the circuit and electrical equipment that will be worked on
- Do tagout/lockout Master Switches
- Wear appropriate PPE after test equipment
- Cover HVD hole with dummy-plug after removing HVD
- Always check "0V" before HV work
- Always cover arms, legs and body with clothes
- Always maintain exit paths clear

DON'TS

- DON'T try to save time by eliminating procedure
- DON'T HV work only you
- DON'T trust safe after only checking TSAL-green
- DON'T work not isolating HV
- Fail to insulate cover for short periods of time
- DON'T work in a small space without cleaning up
- DON'T HV work with rings, watches, and bracelets

Contents

1. Low Voltage Electricity Hazard (750V DC or less, 600V AC or less)
2. Basic knowledge of high-voltage components in JSAE Formula EVs
3. Basic knowledge of personal protective equipment and tools
4. Electric work on high-voltage systems
- 5. Trouble in the past**
6. First aid in the case of incident and fire extinguishing
7. Safety in working with EVs

Case 1

Cells voltage wiring were short-circuited and the entire wire caught fire.

- During charge, a data logger was recorded cells voltage from the inputs on the back. After charge, data logger should be divided using **a connector on the wiring**

- The member who didn't know the connector on wiring, removed Y-terminals from the data logger's input.
- The Wiring shorted the battery pack through the terminals .

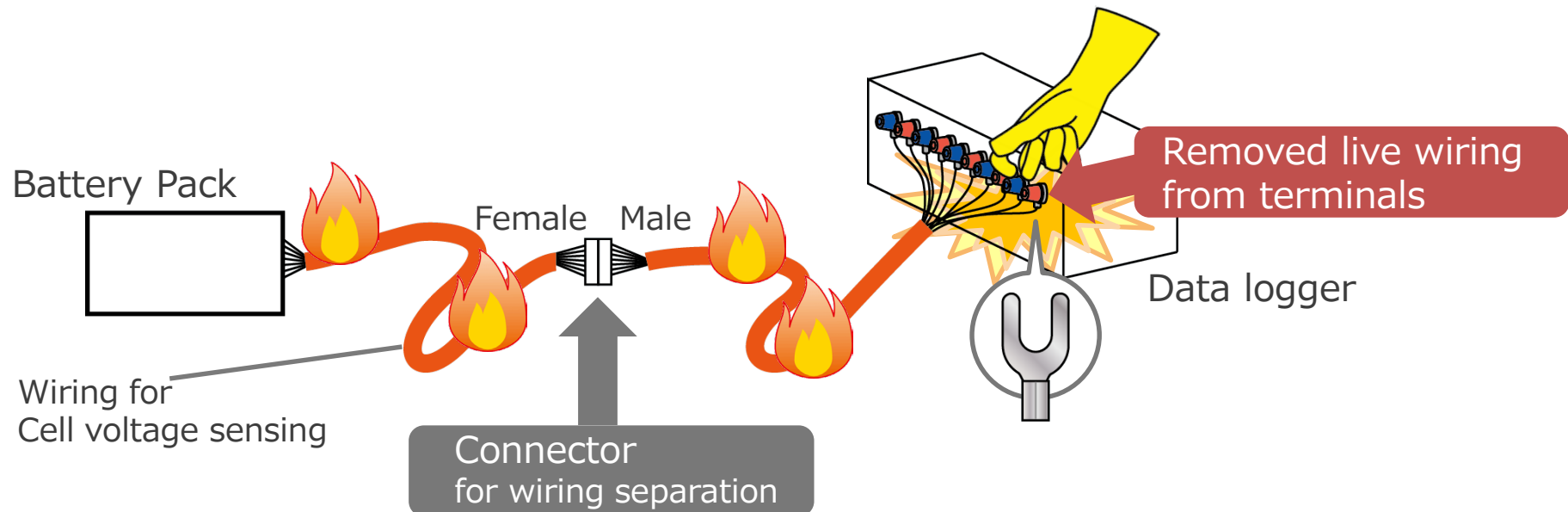

Case 2

The member hand-tightened the nut on the HV terminal.
During charging, the battery caught fire.

- Setting 2sq wiring for DC2A charging.
- The member hand-tightened the wiring to the terminals, and start charging. After the member leave there, the battery caught fire.
- Insufficient torque resulted in an increase in the resistance of the terminal's contacts. Excessive power was applied to the contacts, causing the wires and battery resin to ignite.

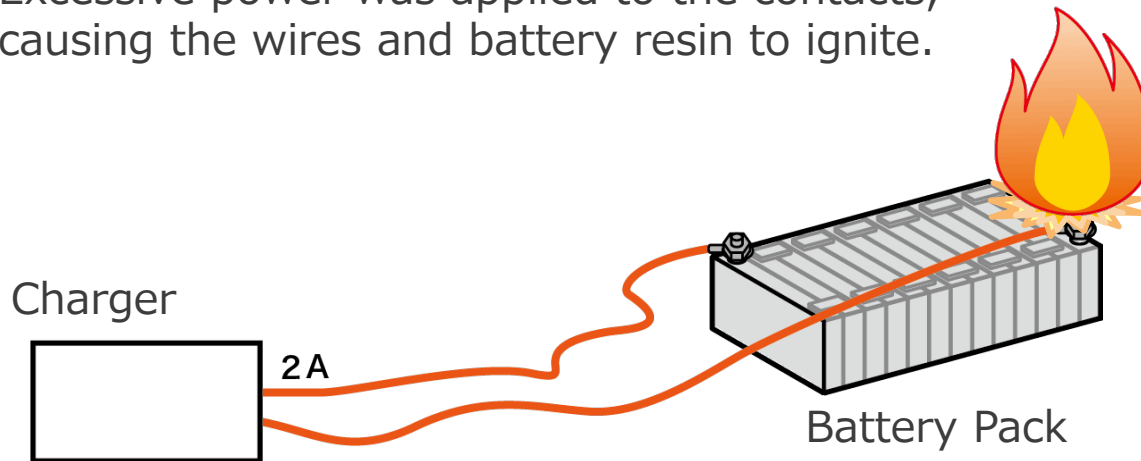

Similar Ex.
Energy Meter, melted wiring



Case 3

Disconnect the battery from the inverter.

The next day, the inverter wiring was short-circuited during re-assembly.

- The members could not foresee the danger of remaining electricity on the capacitors.
- He did not check voltage with a multimeter before operation.
- He did not apply insulation protection to the free terminals.

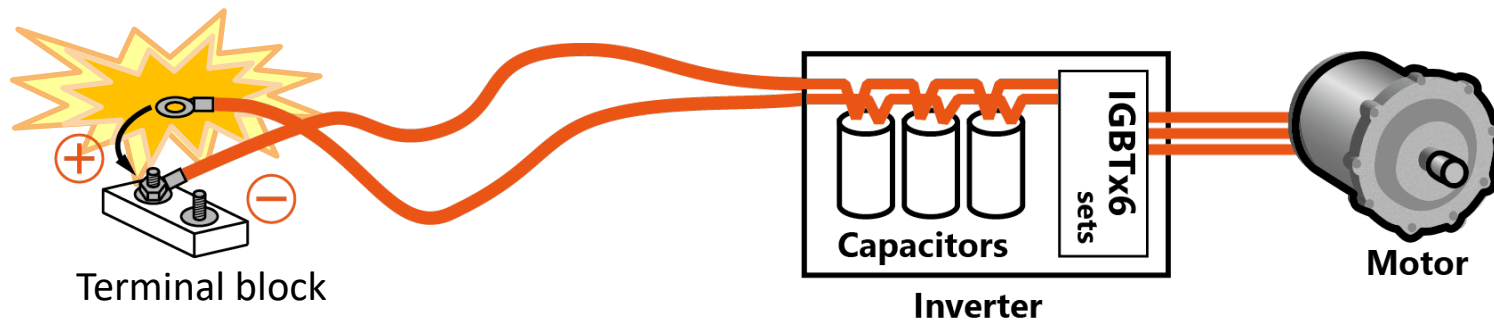

The short circuit made a boom and the member could not hear anything for some time. The part of bolt on the terminal block was gone out.

Case 4

The hand-crimping resistance increased after repeated assembly and disassembly

- Insufficient hand tool crimping
- Lack of knowledge of correct crimping criteria



Case 5

Injured by sparks when connecting the modules in parallel during ACC assembly.

- Before connecting the modules, there are a voltage difference.
- A current flow between modules caused a big spark.

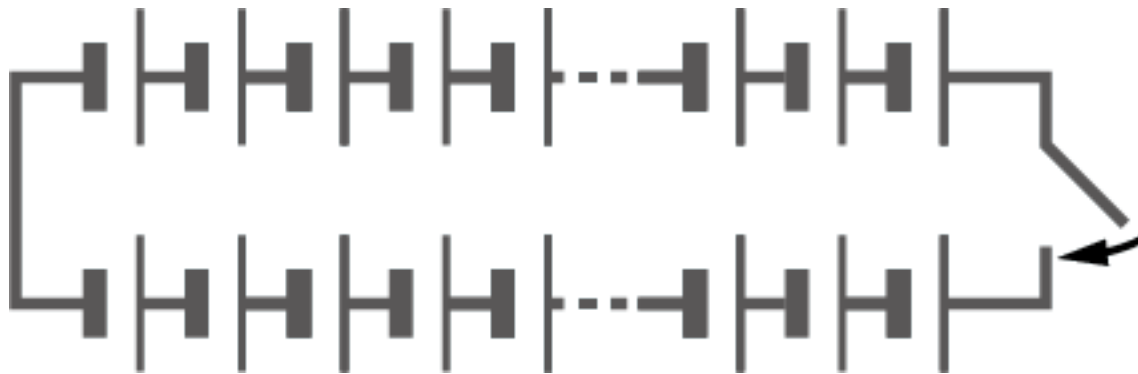

Actual cell voltages (via Aliexpress)

The chart shows actual voltage differences just after the delivery.
Need adjusting cell voltage before assembly.

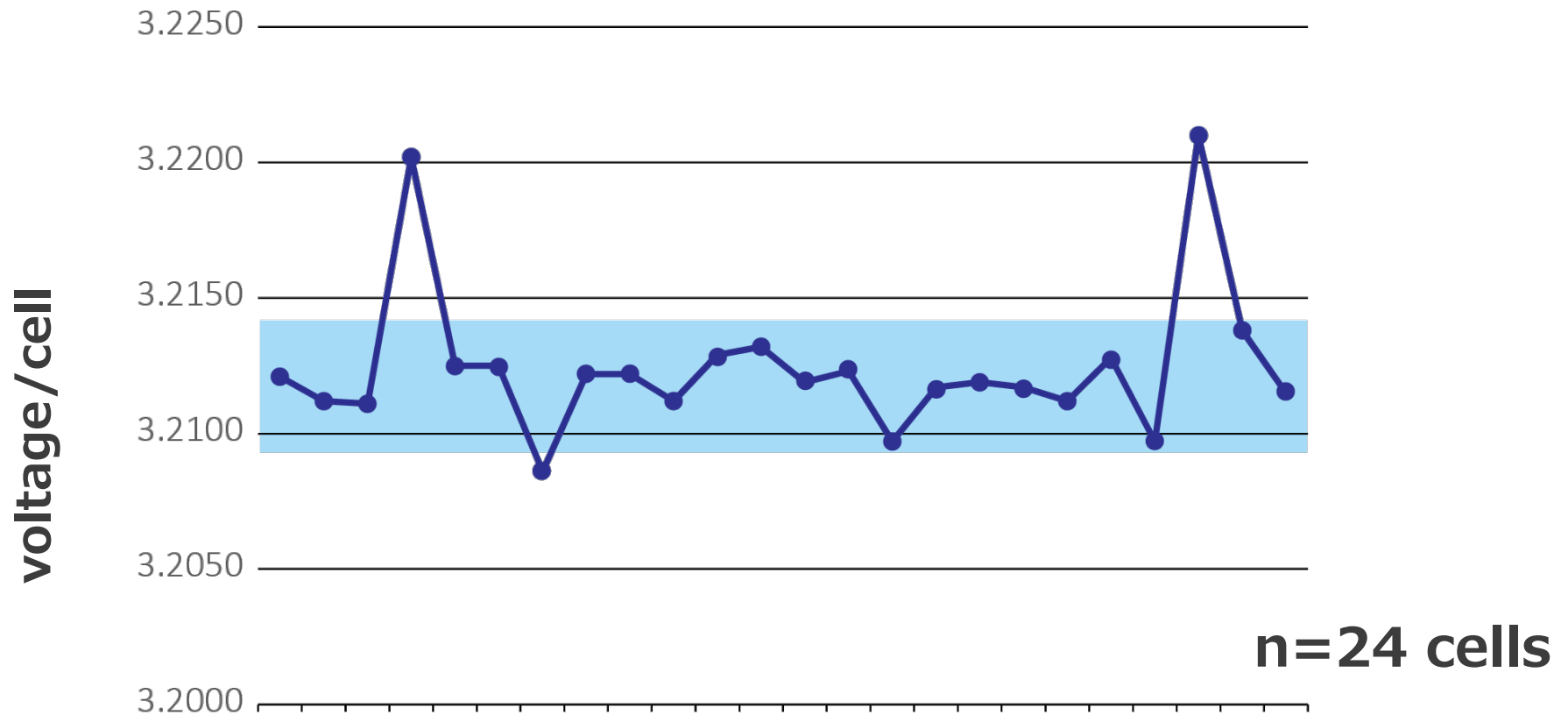

Normally difference of mass production cells voltages are $\leq 10\text{mV}$

Large voltage differences are considered as differences in the history of each cell.

Case 6

When connecting the wiring inside the ACC and his arm touched the metal case of the ACC, he had an electric shock.

- The invisible wiring/terminal contacted to the metal case.
- He has his arms up because of the hot summer.
- Isolation between high voltage circuit and ground had not been verified prior to operation.

Case 7

Accumulator container caught fire while charging without AMS control.

- The battery ECU (AMS) was determined to be faulty because it frequently shut down even after charging.
- The ACC was charged by DC power supply without a shutdown circuit
After that, a fire broke out with a boom.
- After the fire broke out, the fire extinguishers could not extinguish it.
A large quantity of water was spilled from a fire hose.

Case 8

The battery cell ruptured during charge after a member went out.

- The member was charging a cell with recording temperatures and voltages to adjust cell voltage.
- Then he went out to buy an evening meal. it means neglect of monitoring
- When he came back, he found white smoke inside the room. He opened the windows to ventilate the air.

Case 9

When charging the auxiliary battery, the cell swelled and the battery case cracked.

The auxiliary battery was charged to a unique charger on the desk.

After a while, the auxiliary battery case was cracked and the cells were leaking a little electrolyte.

Finally Auxiliary battery was filled with sand and sealed in a metal container



The charger with cell monitoring



Case 10

The wiring has allowed water to enter the accumulator container and there is an electrical leak. This case shows insufficient preparation for the rain test.

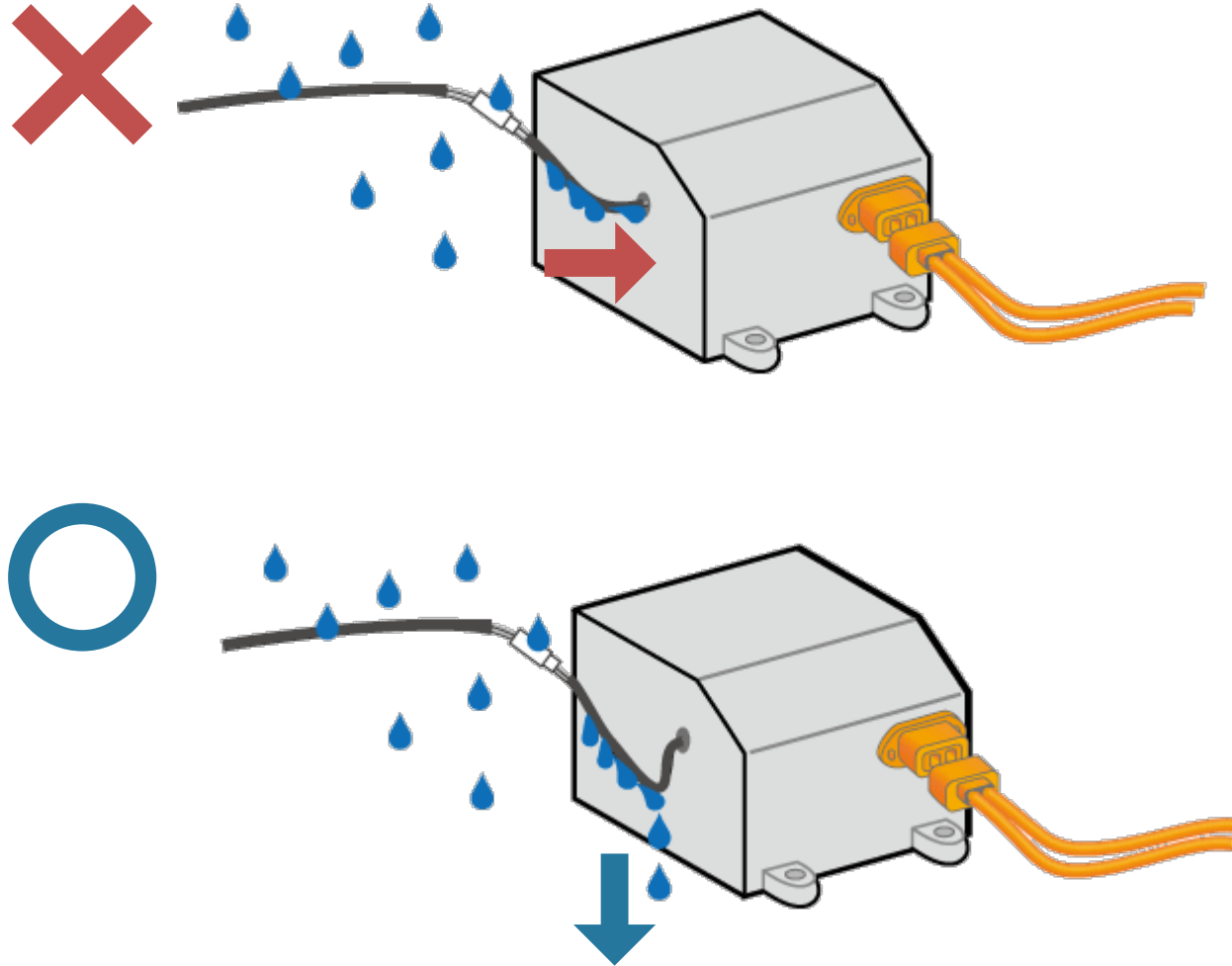

Trouble in the past

1. Cells voltage wiring were short-circuited and the entire wire caught fire.
2. Wiring with hand-tightened HV nut caught fire during charging.
3. The inverter made a large short current 1-day after using it.
4. The crimping resistance increased after repeated assembly and disassembly.
5. Short circuit causes sparking when battery cells are connected in parallel.
6. Electrical shock occurred when a worker touched to the metal of the accumulator container during assembly.
7. During Charging No.1: Accumulator container caught fire during charging without AMS.
8. During charging No. 2: Battery ruptured during cell charging.
9. During charging No. 3: Cells swelled and the case cracked when charging the auxiliary battery.
10. The wiring has allowed water to enter the accumulator container.

Contents

1. Low Voltage Electricity Hazard (750V DC or less, 600V AC or less)
2. Basic knowledge of high-voltage components in JSAE Formula EVs
3. Basic knowledge of personal protective equipment and tools
4. Electric work on high-voltage systems
5. Trouble in the past
- 6. First aid in the case of incident and fire extinguishing**
7. Safety in working with EVs

First aid

- Medical, organizational and caring measures on sick or injured persons with **simple means** including the emergency call.
- Seamless help from the scene of the incident to the hospital can only be ensured by **organizational measures**.
- In the event of an emergency, those present are required to **take action to save lives without harming themselves**

Member's role in seamless support from the field to the hospital

In the event of an emergency, members should take the necessary steps until handover to medical personnel within its own education and training

Team members

Medical professionals



**Preparing in advance
for emergencies,
Member education**



**Emergency
call**



**Organized
first aid**



Process should be simple !

Prepare emergency instruction

- Emergency situations require quick and precise action.
- The following minimum preparations should also be educated to members so that they can take action.

Type	Procedure
In the event of an emergency	<ol style="list-style-type: none"> (1) Notification via the university's emergency contact network (2) Call 119 (3) Provide first aid (4) Guide emergency vehicles to
First Aid	<ul style="list-style-type: none"> • Ventricular fibrillation → AED/cardiac massage, follow #119 instructions • Burn →Cool with water • Bleeding →Compression to stop bleeding • Accidental ingestion →Identify what was swallowed using empty bottles, etc. • Heat stroke →Cool the body in the shade, use vaporization heat, drink water • Adhesion →Rinse with water for at least 15 minutes
Fire Extinguishing	<ol style="list-style-type: none"> (1) Call 911 (2) Rescue of human life (3) Extinguish with a fire extinguisher Run away if the height of the fire exceeds the height of a person.

- Make sure fire extinguishers, hydrants, and AEDs are located.

Prior education for team members

- All team members are aware of the minimum measures to be taken in case of an emergency

Online textbooks are available from the Tokyo Fire Department and other sources.

[一般市民向け 応急手当WEB講習 オンラインテキスト, 消防庁](#)

[普通救命講習 \(短縮救命講習用\) オンラインテキスト, 東京消防庁](#)

[Hands-Only CPR, American heart association](#)

- It is desirable to receive instruction from experts at public institutions

Municipal fire departments offer various training courses

The chart below from Tokyo Metropolitan Fire web page <https://www.tfd.metro.tokyo.lg.jp/lfe/kyuu-adv/life01-1.htm>

応急手当コース					
講習種別	講習時間	講習内容	認定証等の交付	有効期限	お問合せ先
応急救護講習	希望する時間	けがの手当てなどを学ぶコース	交付はありません。	—	都内各消防署
救命入門コース	45分	小学校高学年の方、普通救命講習の受講希望はあるが講習時間が取れない方、これから普通救命講習を受講される方等を対象とした、胸骨圧迫やAEDを中心に学ぶコース	救命入門コース（45分）受講証	—	
	90分		救命入門コース（90分）受講証	—	
普通救命講習	3時間	心肺蘇生やAED、異物除去、止血法などを学ぶコース ※小児や乳児に対する心肺蘇生を中心とした内容をご希望する場合は都内各消防署にご相談ください。	救命技能認定証	3年間	都内各消防署 又は 公益財団法人 東京防災救急協会
普通救命（自動体外式除細動器業務従事者）講習	4時間	普通救命講習の内容に、AEDの知識確認と実技の評価が加わったコース	救命技能認定証 （自動体外式除細動器業務従事者）		
普通救命再講習	2時間20分	前回の普通救命講習受講日から3年以内に再度受講するためのコース。（知識の確認と実技の評価を実施します。）			
		普通救命（自動体外式除細動器業務従事者）講			

Electrocution may result in cardiac arrest

Men and women cannot move, if the current exceeds 9 mA and 6 mA respectively

High current can cause ventricular fibrillation (cardiac arrest, heart lost normal beating)

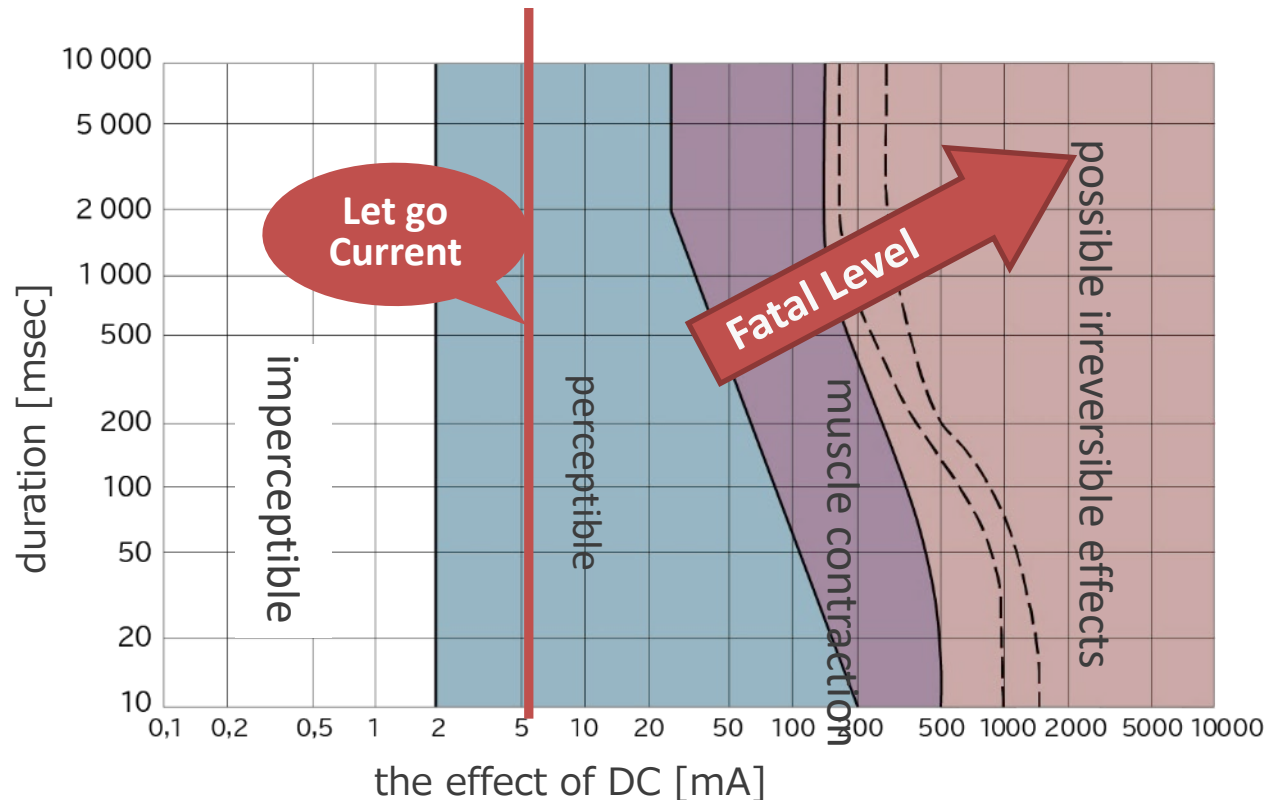

Ventricular fibrillation : Resuscitation related to Chest Compression and AED

- **Cardiopulmonary resuscitation (CPR)** can be performed by anyone
Perform CPR, If a person collapses in front of you and his/her heart or breathing has stopped
- **Heart massage (human chest compressions) for cardiopulmonary resuscitation**
- **Apply AED for restoring normal heart function (defibrillation)**

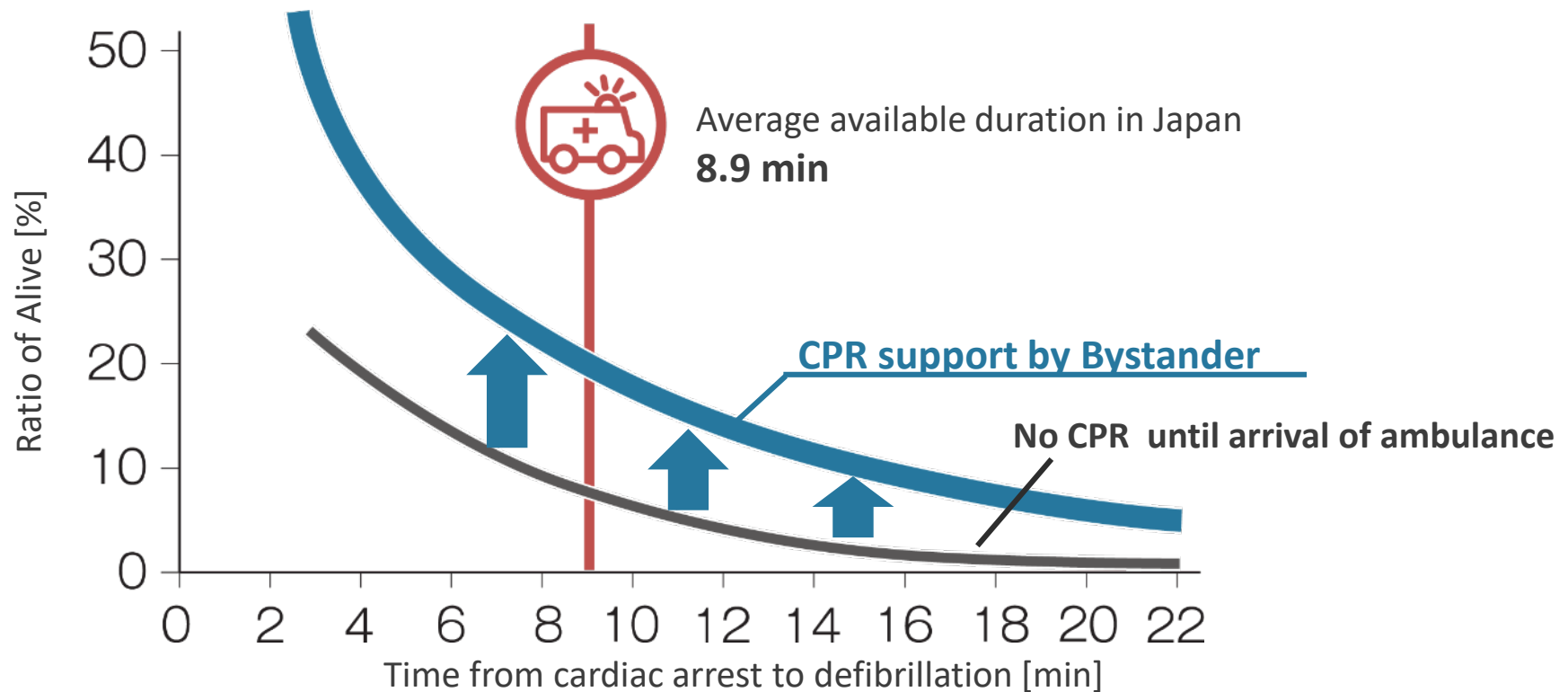

Procedures in case of cardiac arrest

With every minute, the chance of survival of affected persons with ventricular fibrillation decreases by 10-12 %**.^{†1}

The following steps should be taken promptly

Call #119 Emergency number



Chest compressions

Transport oxygen to the tissues



AED automated external defibrillator
Restore normal heart function



First aid increases the survival rate

Chest compressions (cardiac massage) and AED play different roles

AED improves survival rate dramatically, but only about 2% of all patients are saved

Preparing to use an AED is most important thing

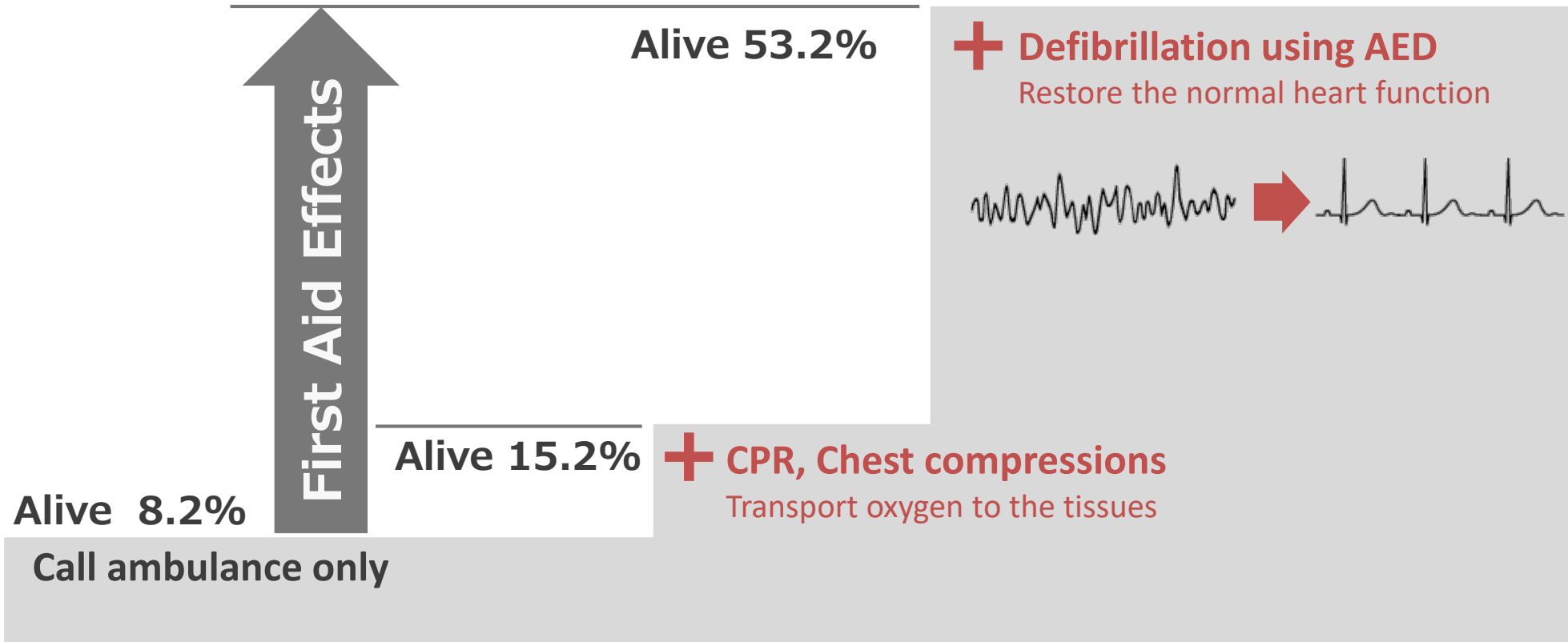

Survival rate of the general public witnessing a cardiac arrest

When you see a person on the ground, call emergency #119 immediately

If the person does not respond to your voice, call emergency before attempting CPR



Start CPR, Chest compressions, before arriving AED

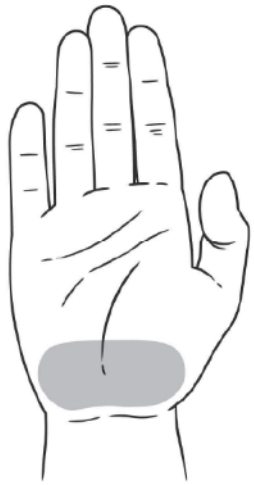

Base of palm



Stretch out your elbow
Push 100-120 times per minute

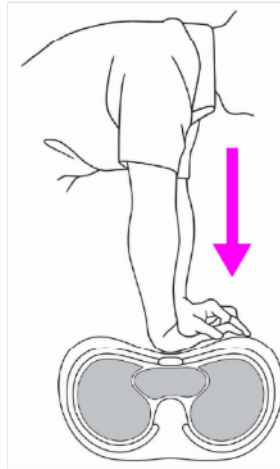

The procedure is given by voice from
emergency contact

The procedure is given by voice from emergency contact

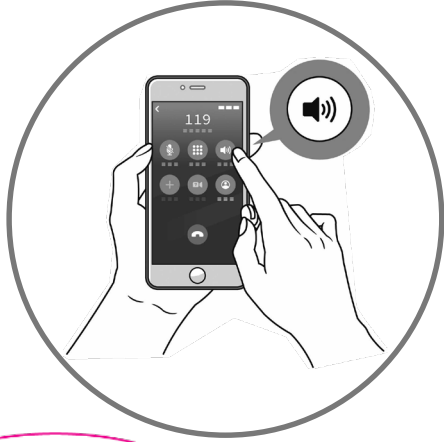

Is there a response
to calling out loudly



Look at the chest
and belly. Is there
normal breathing



Press hard on
the middle
of the chest.



The AED will give you voice instructions on how to proceed

Even if you are not sure whether the patient is responsive or breathing, act as if the patient is in cardiac arrest

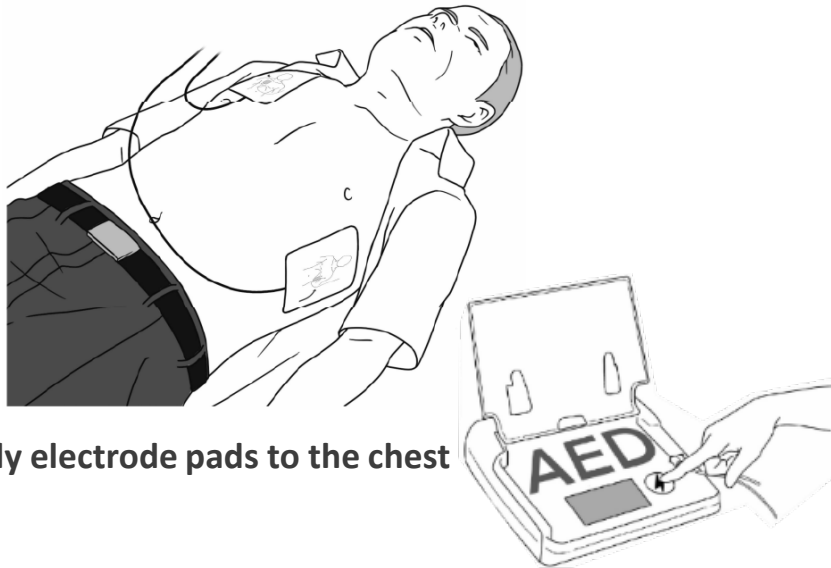

Apply electrode pads to the chest

Follow the AED's voice message



Do NOT touch the body
when instructed to administer electroshock

Summary: First aid in the case of incident

- **Prepare contact information and procedures in advance** to respond quickly in case of an emergency.
- **Provide at least minimum training to members for organized activities**
- **Call emergency #119, if you find a person lying on the ground**
If cardiac arrest is suspected,
 - Start CPR immediately to transport oxygen to the tissues
 - Prepare AED to help the person recover the normal heart beating

How to Use Powder fire extinguisher

**Warn of fire at first !
Escape immediately, when fire
exceeds the height of man**



3 to 5 meters from the fire
Pull out the safety pin



Aim the hose nozzle
at the fire



Squeeze the lever tightly
Aim at the bottom of the flame.

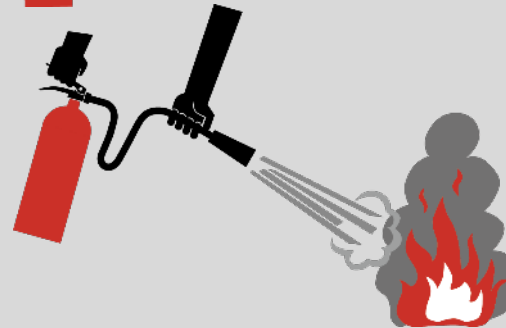

3kg Powder
10~15 seconds

In the building, escape before smoke coming

Warning call for specific action
Emergency call



Start evacuating as soon as possible!

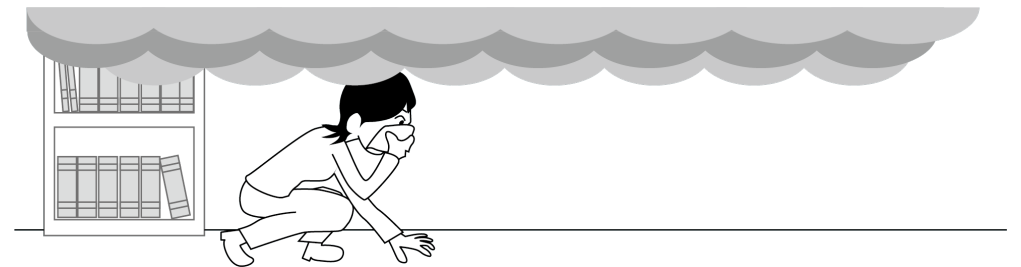
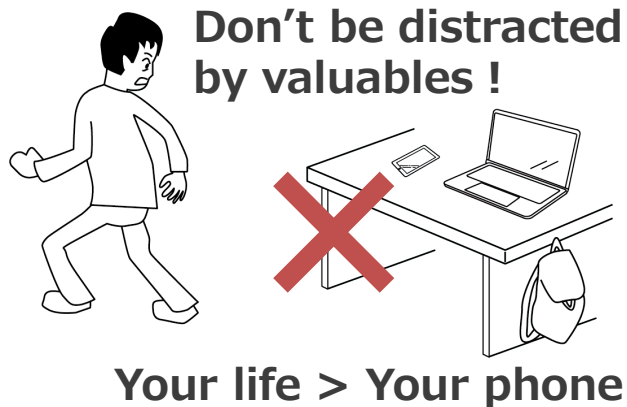

Duckwalk under the smoke

In a building CO2 fire extinguishers are not safe

- **CO2 concentrations used to extinguish fires ($\geq 35\%$) cause immediate loss of consciousness**
 - 10% Loss of consciousness in a few minutes
 - 3-6% headache, dizziness, nausea in a few minutes

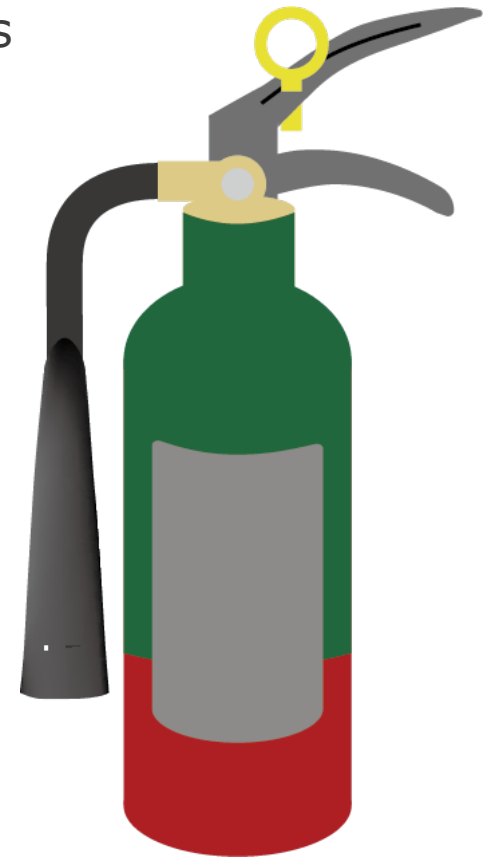

*The Aichi Sky Expo Hall, site for the 2024 Formula SAE Japan event, is equipped with a ventilation system, allowing the use of CO2 fire extinguishers.

Expert knowledge of lithium-ion batteries or battery fires

Lithium-ion batteries can overheat, thermal runaway and ignite for a number of reasons.

In most cases, cells are closely installed in the accumulator container. If one cell ignites, the fire spreads to neighboring cells and may not be extinguished with a few fire extinguishers.

Indoor fires present a significant risk of carbon monoxide poisoning.

Avoid gas poisoning, save your own life, and wait for skilled firefighters arriving.

Lithium-ion batteries should be stored without risk of falling down or dropping.

Cells and the accumulator containers should be stored away from cardboard and other flammable materials. (to preventing the spread of fire)

Contents

1. Low Voltage Electricity Hazard (750V DC or less, 600V AC or less)
2. Basic knowledge of high-voltage components in JSAE Formula EVs
3. Basic knowledge of personal protective equipment and tools
4. Electric work on high-voltage systems
5. Trouble in the past
6. First aid in the case of incident and fire extinguishing
- 7. Safety in working with EVs**

During competition and daily operation

<Works related to vehicle>

- Check TSAL is OFF or Green
- Check the voltage between HV+ and HV- is less than 60V
- **It is strongly recommended to the disconnect HVD** except when working to turn on TS
- **ESO must control the disconnected HVD**

< Works related to TS >

- The work area must be protected with barriers to prevent unauthorized access.
- Mark the work area with a high voltage warning sign
- ESO must be present at all work
- Work to be done with TS turned OFF
 - TSMS must be turned off and the ESO must control the disconnected TSMS key
 - Confirm that TS voltage is 0V
(Confirm that there is no remaining voltage in the inverter input capacitors.)
- Work to be done with TS turned ON (active state) (failure analysis, adjustment, etc.)
 - Use insulated tools
 - Wear safety glasses and HV insulating gloves
- Any work on the Accumulator containers, cells, or Segments must be performed in the designated area during the competition

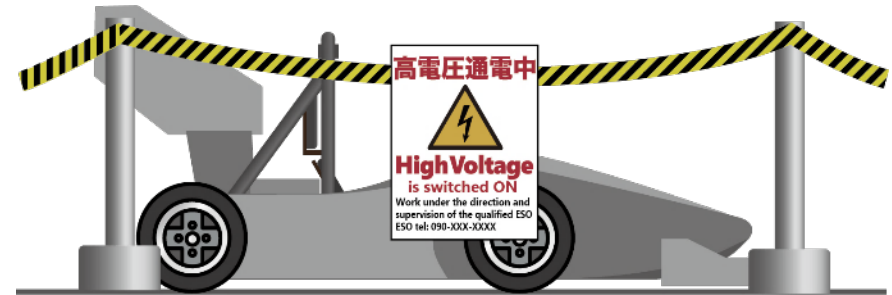

Basics at the Competition Site

<Preparation before dynamic event>

- **ESO must be with the EV**
- HV insulating gloves and a multimeter(probe with protective sleeve) must be accompany the EV

< Pushing the vehicle around the competition site>

- **ESO must be with the EV**
- TSMS is disconnected and the ESO must control the TSMS key
- Insert a dummy HVD after disconnect **the HVD**
- The ESO must control the disconnected HVD (except when the officials move the EV in the dynamic event)
- HV insulating gloves and a multimeter(probe with protective sleeve) must be accompany the EV

HV insulating gloves and a multimeter (probe with protective sleeve)



ESO must be with the EV



HV insulating gloves and a multimeter (probe with protective sleeve)

ESO must be with the EV

When charging at the competition site

- The Accumulator Container must be charged at a designated area
- **ESO must be with the Accumulator Container**
- During transport and charging, the Accumulator Container removed from the vehicle must be secured to the hand cart
- Fire extinguisher(s) must accompany the Accumulator Container
- If one cell ignites, the fire spreads to neighboring cells and may not be extinguished with a few fire extinguishers.
Save your own life, and wait for skilled firefighters arriving.
- The following signs will be posted in the charging area.

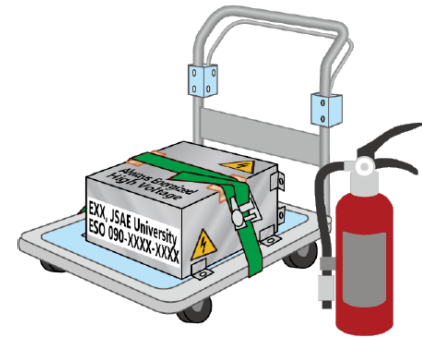

火災に関する注意

火災が発生時には落ち着いて行動し、オフィシャルに通知してください。すぐに行動する必要がある場合は、下記の情報に基づき、最も安全な行動を取ってください。

Accumulator Containerの異臭 / 異音 / 発火に気づいたら

- すみやかに充電器の電源を切ってください
- 大声でオフィシャルを呼んでください

充電中には

- ACCは充電用ハンドカートに乗せること
- 消火器を準備すること
- 充電手順の知識を持つメンバーが少なくとも1人は残ること

FIRE SAFETY NOTICE

IN THE EVENT OF FIRE, STAY CALM. NOTIFY THE OFFICIALS. IF YOU MUST TAKE IMMEDIATE ACTION, USE YOUR JUDGEMENT AS TO THE SAFEST COURSE OF ACTION, GUIDED BY THE FOLLOWING INFORMATION:

If The Odor/Noise/Fire is from The Accumulator Container

- TURN OFF CHARGER IMMEDIATELY
- Call Officials LOUDRY

During charge chage

- The ACC(s) should be on the hand cart for charging
- Prepare Fire Extinglisher(s)
- At least one team member who has knowledge of the charging process must stay

End of Slides